



OptiFlow™ Belt Stacker



Operator Guide
US/Canada English Version

Note: This equipment has been tested and found to comply with the limits for a Class A digital device, pursuant to part 15 of the FCC Rules. These limits are designed to provide reasonable protection against interference when the equipment is operated in a commercial environment. This equipment generates, uses, and can radiate radio frequency energy and, if not installed and used in accordance with the instruction manual, may cause interference to radio communications. Operation of this equipment in a residential area is likely to cause interference in which case the user will be required to correct the interference at his own expense.

CAUTION: Changes or modifications to this equipment not expressly approved by the party responsible for compliance could void the user's authority to operate the equipment.

SV40231 Rev. A 5/05

©2005 Pitney Bowes Inc. All rights reserved.

This book may not be reproduced in whole or in part in any fashion or stored in a retrieval system of any type or transmitted by any means, electronically or mechanically, without the express, written permission of Pitney Bowes. We have made every reasonable effort to ensure the accuracy and usefulness of this manual; however, we cannot assume responsibility for errors or omissions or liability for the misuse or misapplication of our products.

Due to our continuing program of product improvement, equipment and material specifications as well as performance features are subject to change without notice. Your machine may not have some of the features described in this book.

E-Z Seal and OptiFlow are trademarks or registered trademarks of Pitney Bowes Inc. ENERGY STAR is a registered trademark of the United States Environmental Protection Agency.

Pitney Bowes Contact List



If You Need Assistance

USA Contacts

- Product Name - OptiFlow™ Belt Stacker
- Model - F680
- For frequently asked questions, go to: www.pb.com and click on **Customer Support**.
- To place requests for service or training, go to: www.pb.com and click on **My Account**.
- To order PB supplies and accessories, go to: www.pb.com and click on **Online Store**.
- To view and pay invoices online, go to: www.pb.com and click on **My Account**.
- To view inventory, go to: www.pb.com and click on **My Account**.
- For direct questions, call: 1.800.522.0020. Customer Service Representatives are available Monday through Friday, 8:00 AM - 8:00 PM ET.

Canada Contacts

- Product Name - OptiFlow™ Belt Stacker
- Model - F680
- For frequently asked questions or to order supplies, go to: www.pitneybowes.ca
- For direct questions, call: 1.800.672.6937. Customer Service Representatives are available Monday through Friday, 8:30 AM - 4:00 PM ET.

Important Safety Notes

Follow these precautions whenever you use your belt stacker:

- Read all instructions before you attempt to operate the system. Keep the Operator Guide accessible for quick reference.
- Use this equipment only for its intended purpose.
- Place the system close to an easily accessible wall outlet.
- Place the system in an accessible location to allow for proper venting of the equipment and to facilitate servicing.
- Use the power cord supplied with the machine and plug it into a properly grounded wall outlet that is located near the machine and easily accessible. Failure to properly ground the machine can result in severe personal injury and/or fire.
- The power cord wall plug is the primary means of disconnecting the machine from the AC supply.
- DO NOT use a wall outlet controlled by a wall switch or one that is shared with other equipment.
- DO NOT use an adapter plug on the line cord or wall outlet.
- DO NOT remove the ground pin from the line cord.
- Make sure the area in front of the wall outlet into which the machine is plugged is free from obstruction.
- DO NOT route the power cord over sharp edges or trap it between pieces of furniture. Make sure there is no strain on the power cord.
- To reduce the risk of fire or electrical shock, DO NOT attempt to remove covers or disassemble the control panel or its base. The cabinet encloses hazardous parts. If you should damage the unit, contact Your system supplier. Refer to the *Contact Information List* at the front of this guide for more information.
- If the unit becomes damaged, unplug it from the wall, then contact Your system supplier. Refer to the *Contact Information List* at the front of this guide for more information.
- Keep fingers, long hair, jewelry and loose clothing away from moving parts at all times.
- Avoid touching moving parts or materials while the machine is in use. Before clearing a jam, be sure machine mechanisms come to a complete stop.
- Remove jammed material gently and carefully.

continued>

Important Safety Notes (continued)

- Do not place lighted candles, cigarettes, cigars, etc., on the system.
- To prevent overheating, do not cover vent openings.
- Use only approved supplies, in particular aerosol duster. Improper storage and use of aerosol dusters or flammable aerosol dusters, can cause an explosive-like condition that could result in a personal injury and/or property damage. Never use aerosol dusters labeled flammable and always read instructions and safety precautions on the duster container label.
- To obtain supplies and/or Material Safety Data Sheets, contact your system supplier. Refer to the *Contact Information List* at the front of this guide for more information.
- Operation of this equipment without periodic maintenance will inhibit optimum operating performance and could cause the equipment to malfunction. Contact your system supplier for the required service schedule.
- Always follow specific occupational safety and health standards for your workplace.
- To reduce the risk of fire or electrical shock, DO NOT attempt to remove covers or disassemble the control panel or its base. The cabinet encloses hazardous parts. If you should damage the unit, contact your system supplier. Refer to the *Contact Information List* at the front of this guide for more information.

Before setting up and using the Optiflow™ belt stacker you should be thoroughly familiar with its controls and setup procedure. You should also be thoroughly familiar with each component of the Inserting system the belt stacker is being used with.

This Guide is organized into three chapters:

Chapter 1 - Introduction

Gives basic details of your belt stacker. This section includes:

What the Belt Stacker Does	1-1
Main Components	1-3
The Control Panel	1-4
Principle of Operation	1-4

Chapter 2 - Operation

Gives the basic steps required to process documents. It explains:

Use with the DI500/DI600 Inserters

Setup of Right Angled mode	2-1
Operation in Right Angled mode	2-2

Use with the DI800 Inserter

Setup of Right Angled mode	2-4
Operation in Right Angled mode	2-6
Setup of In Line mode	2-7
Operation in In Line mode.....	2-9

Use with the DI875 Inserter

Setup of Right Angled mode	2-11
Operation in Right Angled mode	2-13
Setup of In Line mode	2-15
Operation in In Line mode.....	2-16

Contents

Use with the DI900/DI950 Inserters

Setup of Right Angled mode	2-18
Operation in Right Angled mode	2-20
Setup of In Line mode - 'Letter' sized envelopes	2-22
Operation in In Line mode - 'Letter' sized envelopes	2-24
Setup of In Line mode - 'Flats' sized envelopes.....	2-25
Operation in In Line mode - 'Flats' sized envelopes	2-27

<i>The Tandem Belt Stacker.....</i>	2-28
--	-------------

<i>Use of the Belt Stacker with Other Equipment.....</i>	2-28
---	-------------

Chapter 3 - Reference

Covers subjects that may only be required occasionally. It includes:

Troubleshooting	3-1
Service	3-2
Specifications.....	3-3

What the Belt Stacker Does

General

The stacker is designed as an output device for a range of Inserting Systems and also as a general output device for other machines such as address printers.

This guide covers use of the belt stacker in all configurations.

Configurations

The belt stacker can operate at right angles (to the left or right) and also in-line with the machine outputting to it, depending on machine and/or material being used.

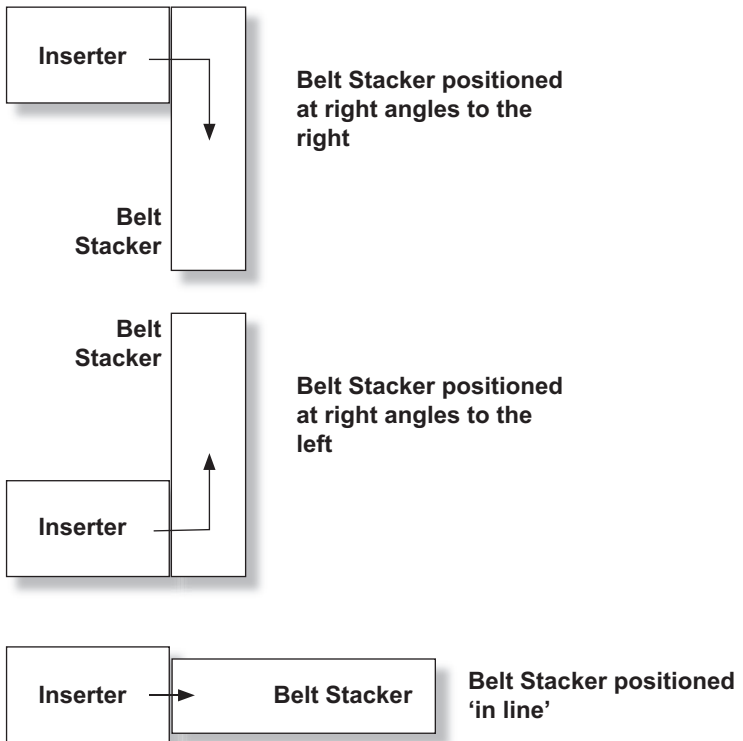

1 • Introduction

The control panel can be positioned on either side of the stacker to accommodate the different configurations possible. It incorporates a variable speed control, run-out button, power switch and power supply.

In most cases, the belt stacker is mounted on height adjustable legs. However, versions without legs are available that can be placed on an existing table of the correct height. In these cases, no adjustment of the belt stacker height is possible.

The DI900/DI950 Inserters output small ('letter') envelopes at a different height to large ('flat') envelopes. Tandem belt stacker configurations are available to allow automatic stacking of both envelope sizes simultaneously.

Your Model

The belt stacker is tailored to work with the particular machine outputting to it, and the configuration used, by the addition of kits. Your stacker will be supplied with only the correct kit(s) for your particular installation.

This guide explains setup and operator adjustments for each machine combination, but assumes that the stacker has been previously installed by a service representative and that all necessary kits of adapters and parts are available.

In most cases, it is NOT possible to change the belt stacker configuration or link the stacker to a different Inserter without some modifications being necessary. If you wish to do this, contact your machine supplier for advice.

Main Components

Take a few minutes to become familiar with the components of the belt stacker.

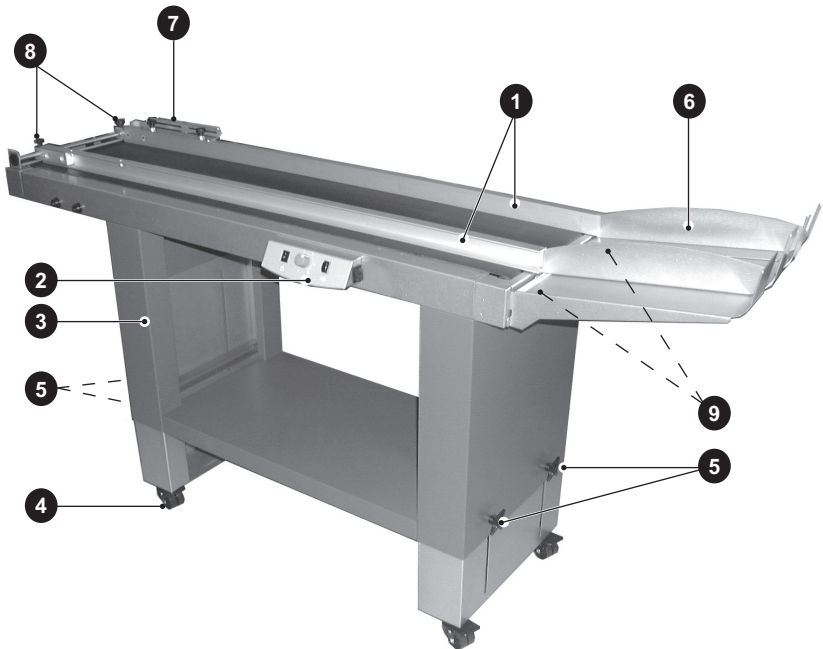

- 1 Side guides
- 2 Control panel box
- 3 Leg assembly
- 4 Lockable castors
- 5 Height adjustment knobs (two on each leg)
- 6 Stacking tray
- 7 Entry guide (varies with machine configuration)
- 8 Front end side guide adjustment knobs
- 9 Rear end side guide adjustment knobs (underneath, not visible)

Note: Certain models do not have a stand (items 3, 4 and 5) if they are being used on a table of the correct height.

1 • Introduction

The Control Panel

The control panel can be positioned on either side of the stacker, depending on system configuration.

To change the position of the control panel, pull the panel firmly towards you to remove it. Refit the control panel to the opening on the opposite side of the belt stacker.

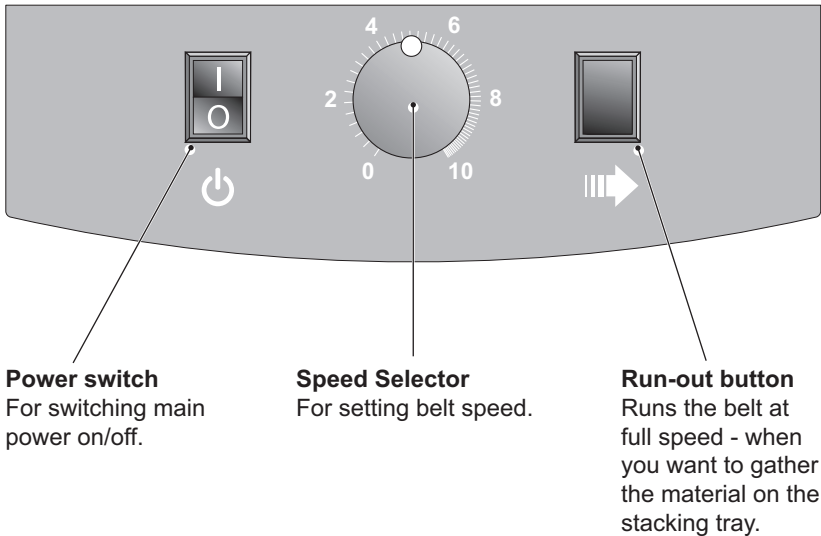

Principle of Operation

The belt will start as soon as the start sensor is covered. When the material has moved out of the sensor area, the belt will stop again. The Start sensor position is adjustable, which allows the material overlap to be adjusted.

The speed of the belt can be adjusted in order to optimize the stacking function for various materials.

The Run-out button is used to gather the material after a job is finished. The belt moves at the highest speed, independent of the Speed Selector setting.

Use with DI500/DI600 Inserters

Setup of Right Angled mode with DI500/DI600 Inserters

The illustration below shows the belt stacker correctly docked to the DI500/DI600 Inserter.

The stacker is used in a right angled orientation.

Follow the steps to correctly set up the stacker:

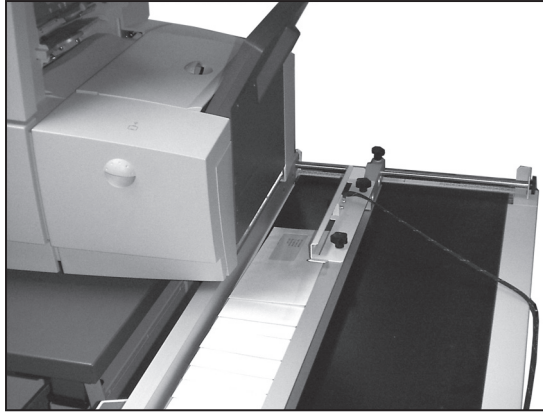

1. Check the stacker alignment. It should be level and the stacker belt should be about 4" to 4-1/4" (100mm to 110mm) below the Inserter output slot. If necessary, loosen the height adjustment knobs (**A**) on each leg in turn and readjust the stacker height.

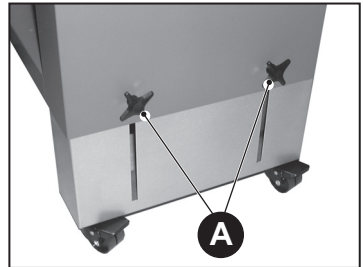

2. Loosen the front and rear end knobs (**B**) of the side guide **closest to the inserter output** and move the side guide as far open (in the direction of the arrow) as it will go. Retighten the front and rear end knobs.

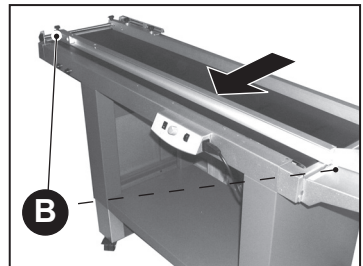

2 • Operation

3. Position the belt stacker with the side guide under the Inserter output as shown.

Make sure the Inserter output is level with or *just* overlapping the guide.

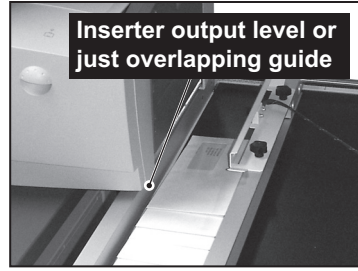

4. Lock all four castors.

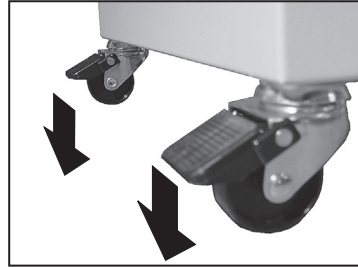

5. For right hand operation; the sensor and sensor bracket (C) will have been installed as shown.

For left hand operation the parts are installed mirrored.

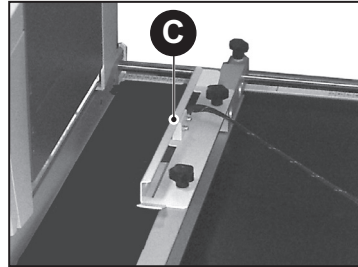

Operation in Right Angled mode with DI500/DI600 Inserters

1. Place one envelope on the belt.

2. Loosen the front and rear end side guide knobs (A) of the side guide **with the sensor bracket** only.

Make sure the side guide rests on the belt!

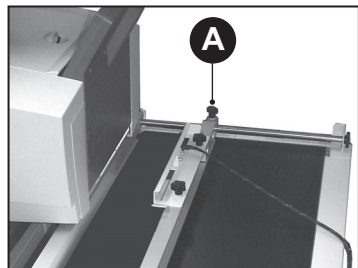

- Adjust the side guide to give a clearance of about 1/8" (3mm) and retighten the front and rear end side guide knobs.

Make sure the side guides are parallel!

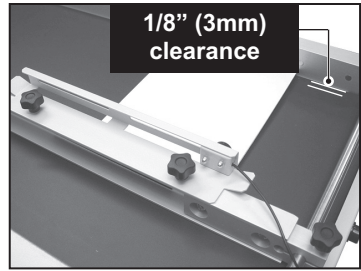

- Read the safety information on page 1-1, then connect the belt stacker to the power supply and turn ON.

- Set the belt speed to maximum.

- Start the DI500/DI600 system.

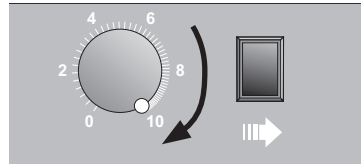

- Adjust the envelope overlap by moving the start sensor. When the sensor is moved away from the inlet the distance between the envelopes will be larger, and vice versa.

Keep the step as small as possible without envelopes building up too much. That way you can optimize the belt capacity!

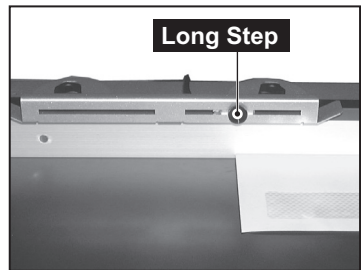
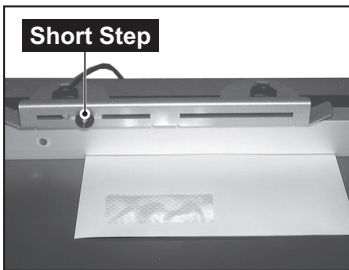

- Reduce the belt speed until the motor runs continuously.

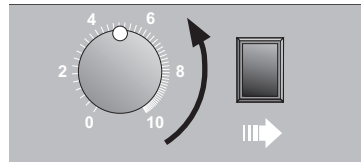

2 • Operation

Use with the DI800 Inserter

The belt stacker can be used in Right Angled or In Line configuration with the DI800 Inserter. In Line mode is preferred for running heavy, large envelopes.

Right Angled setup and operation is described below. In Line setup and operation is described on page 2-7.

Setup of Right Angled mode with the DI800 Inserter

The illustration below shows the belt stacker correctly docked to the DI800 Inserter in a right angled orientation.

Follow the steps to correctly set up the stacker:

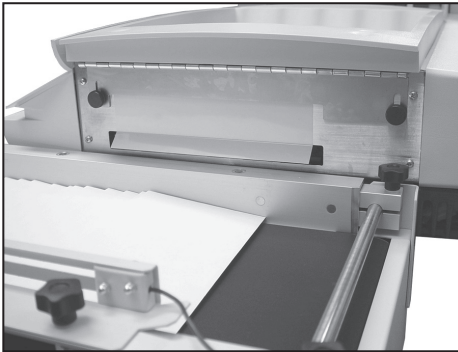

1. Check the stacker alignment. It should be level and the Inserter output should be just above the side guide as shown above. If necessary, loosen the height adjustment knobs (A) on each leg in turn and readjust the stacker height.

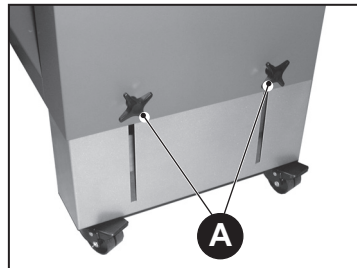

2. Loosen the front and rear end knobs **(B)** of the side guide **closest to the inserter output** and move the side guide as close as possible to the inserter. Retighten the front and rear end knobs.

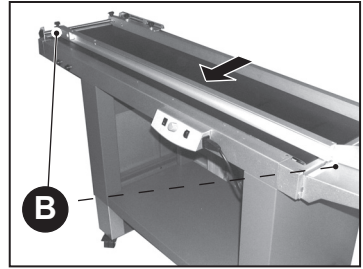

3. Position the belt stacker as close to the inserter as possible and lock all four castors.

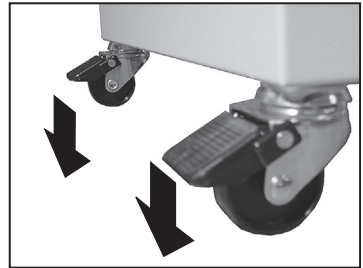

4. For right hand operation the sensor and sensor bracket **(C)** will have been installed as shown in the picture. For left hand operation the parts are installed mirrored.

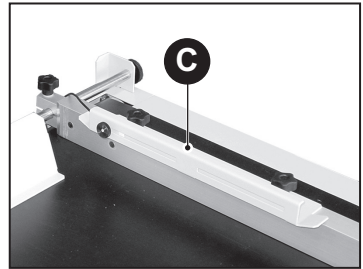

5. The Inserter exit deflector must be fully raised. If necessary, loosen the two knobs **(D)** on the Inserter and move the deflector to its top position. Retighten knobs.

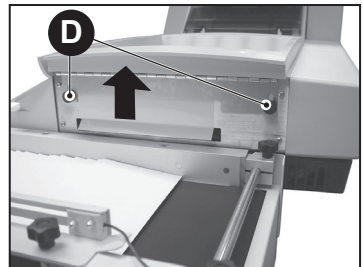

2 • Operation

Operation in Right Angled mode with the DI800 Inserter

1. Place one envelope on the belt.

2. Loosen the front and rear end side guide knobs (A) of the side guide **with the sensor bracket** only.

Make sure the side guide rests on the belt!

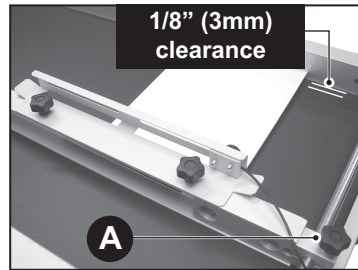

3. Adjust the side guide to give a clearance of about 1/8" (3mm) and retighten the front and rear end side guide knobs.

Make sure the side guides are parallel!

4. Read the safety information on page 1-1, then connect the belt stacker to the power supply and turn ON.

5. Set the belt speed to maximum.

6. Start the DI800 system.

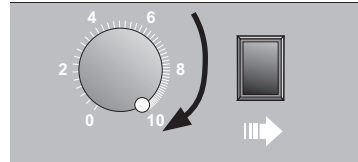

7. Adjust the envelope overlap by moving the start sensor. When the sensor is moved away from the inlet the distance between the envelopes will be larger, and vice versa.

Keep the step as small as possible without envelopes building up too much. That way you can optimize the belt capacity!

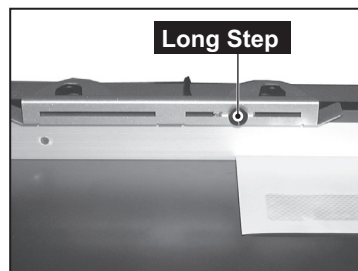
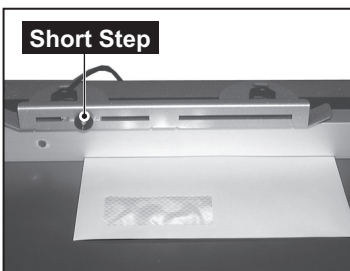

8. Reduce the belt speed until the motor runs continuously.

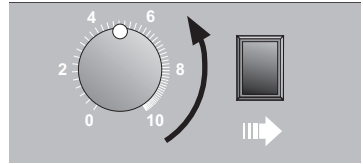

Setup of In Line mode with the DI800 Inserter

The illustration below shows the belt stacker correctly docked to the DI800 Inserter in the In Line orientation.

Follow the steps to correctly set up the stacker:

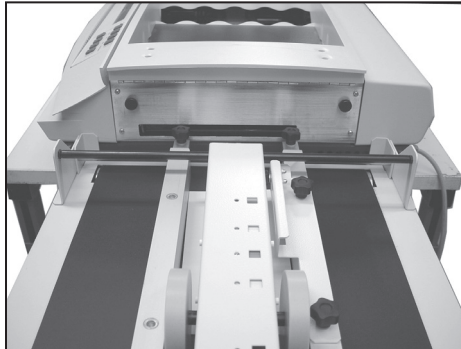

1. The Inserter exit deflector must be removed for operation with the belt stacker.

If necessary, remove the deflector from the Inserter by loosening the two knobs (A).

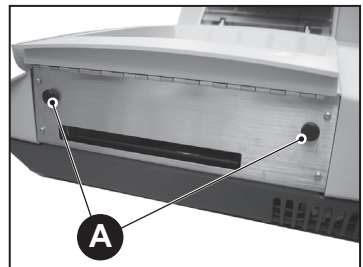

2 • Operation

2. The in line idler rollers (**B**) and sensor bracket (**C**) will have been installed as shown in the illustration.

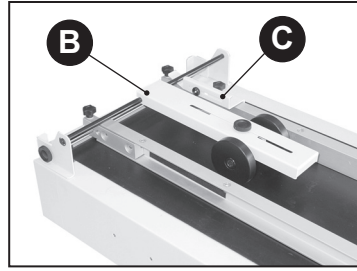

3. Position the stacker as illustrated. The upper outer corner of the sensor side guide should be aligned with the lower left output corner of the Inserter.

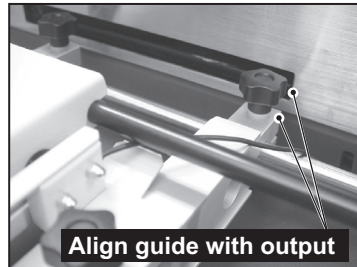

If necessary, loosen the height adjustment knobs (**A**) on each leg in turn and readjust the stacker height.

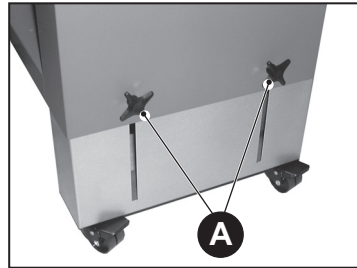

4. When positioned correctly, lock all four castors.

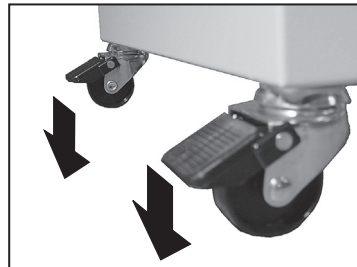

Operation in In Line mode with the DI800 Inserter

1. Set the side guides for the material being used:

Basic setting for side guides for #10 size envelopes:

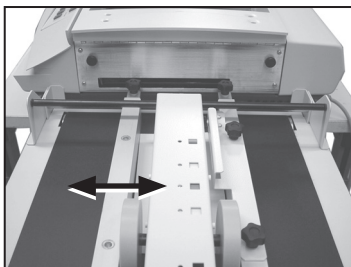

Basic setting of side guides for 9"X12" size envelopes:

Only the side guide **without** the sensor needs to be moved when changing format. Always leave about 1/4" (6mm) clearance between the guide and envelopes.

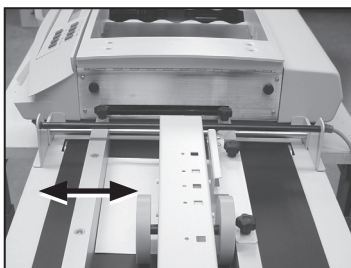

2. Adjust the idler wheel position. Place an envelope with its trailing edge underneath the black shaft, slide the wheels so that they align with the leading edge of the envelope.

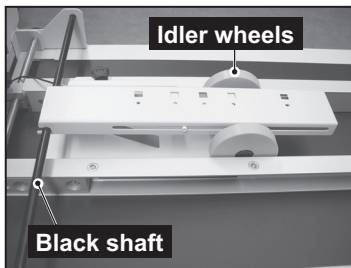

3. Read the safety information on page 1-1, then connect the belt stacker to the power supply and turn ON.

4. Set the belt speed to maximum.

5. Start the DI800 system.

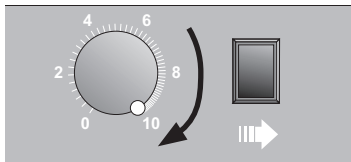

2 • Operation

6. Adjust the envelope overlap by moving the start sensor. When the sensor is moved away from the inlet the distance between the envelopes will be larger, and vice versa. (Illustrations below show sensor setting with idler wheels removed for clarity).

Keep the step as small as possible without envelopes building up too much. That way you can optimize the belt capacity!

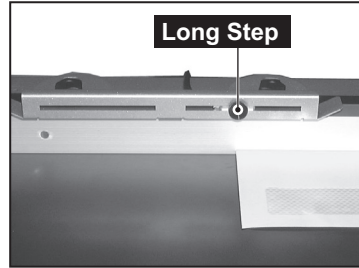
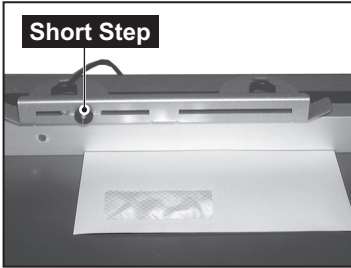

7. Reduce the belt speed until the motor runs continuously.

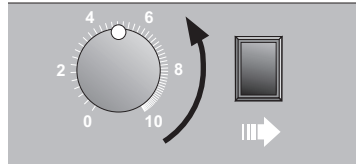

Use with the DI875 Inserter

The belt stacker can be used in Right Angled or In Line configuration with the DI875 Inserter. In Line mode is preferred for running heavy, large envelopes.

Right Angled setup and operation is described below, In Line setup and operation is described on page 2-15.

Setup of Right Angled mode with the DI875 Inserter

The illustration below shows the belt stacker correctly docked to the DI875 Inserter in a right angled orientation.

Follow the steps to correctly set up the stacker:

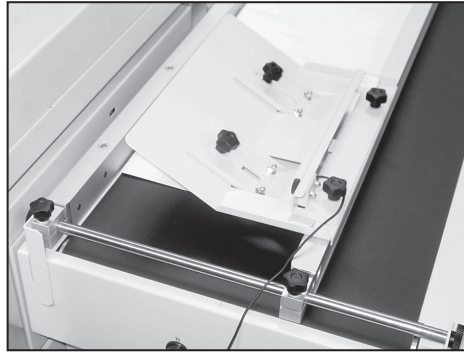

1. The entry guide, sensor bracket and sensor will have been installed as shown.
For right hand orientation, the parts are installed mirrored.

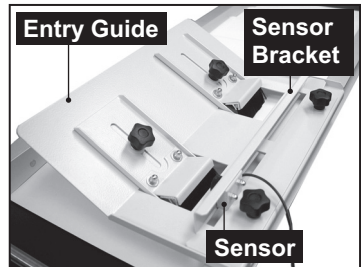

2. Make sure the exit roller shaft has been installed onto the Inserter.



2 • Operation

3. Check the stacker alignment. It should be level and, when positioned against the Inserter, the docking studs on the stacker should fit into the cut-out on the Inserter.

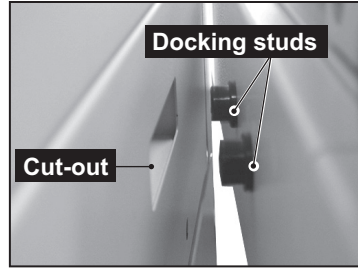

If not correct, loosen the height adjustment knobs (A) on each leg in turn and readjust the stacker height.

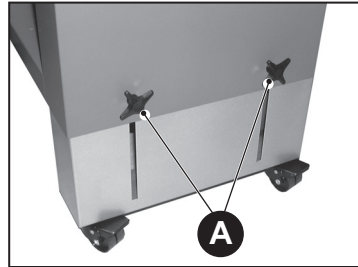

4. When positioned correctly, lock all four castors.

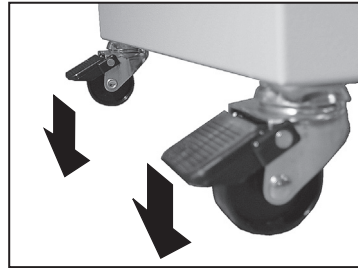

5. Loosen the front and rear end knobs of the side guide closest to the inserter output and move the side guide as close as possible to the inserter.

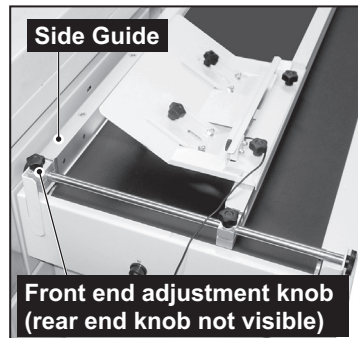

Operation in Right Angled mode with the DI875 Inserter

1. Place one envelope on the belt.
2. Loosen the front and rear end side guide knobs (**A**) of the side guide **with the sensor bracket** only.

Make sure the side guide rests on the belt!

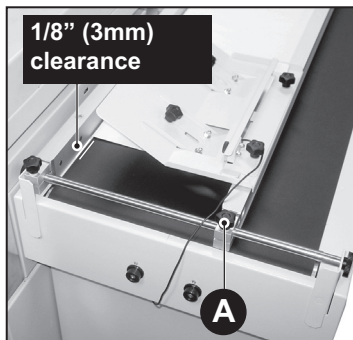

3. Adjust the side guide to give a clearance of about 1/8" (3mm) and retighten the front and rear end side guide knobs.

Make sure the side guides are parallel!

4. Loosen the brush adjustment knobs (**B**) and set the brush position on the entry guide. The brushes should **just** touch the envelope. Retighten the adjustment knobs.

The setting depends on envelope size, thickness, inserter speed and belt speed.

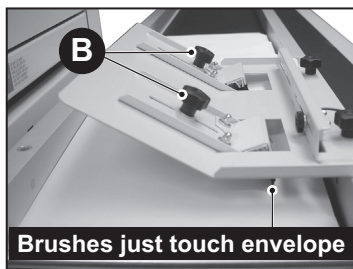

If the brushes are set too tight/low the envelopes will not get into position.

If the brushes are set to loose/high the envelopes could bounce back and cause stoppages.

5. Read the safety information on page 1-1, then connect the belt stacker to the power supply and turn ON.
6. Set the belt speed to maximum.

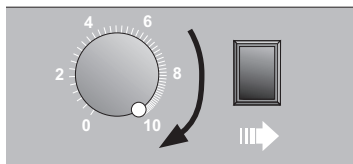

2 • Operation

7. Start the DI875 system.
8. Adjust the envelope overlap by moving the start sensor. When the sensor is moved away from the inlet the distance between the envelopes will be larger, and vice versa.

Keep the step as small as possible without envelopes building up too much. That way you can optimize the belt capacity!

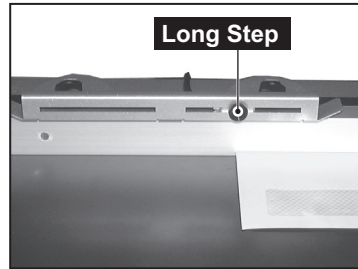
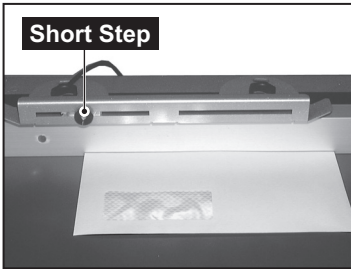

9. Reduce the belt speed until the motor runs continuously.

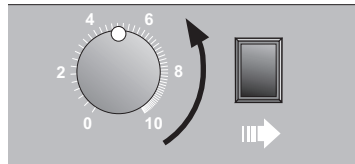

Setup of In Line mode with the DI875 Inserter

The illustration below shows the belt stacker correctly docked to the DI875 Inserter in the In Line orientation.

Follow the steps to correctly set up the stacker:

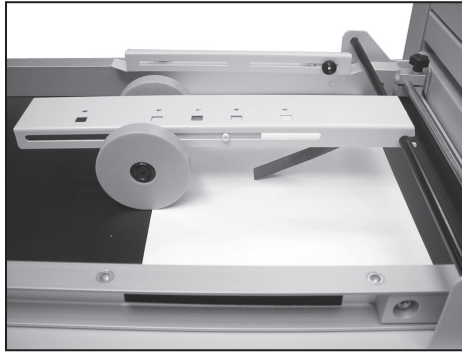

1. The in line idler rollers (**A**) and sensor bracket (**B**) will have been installed as shown in the illustration.

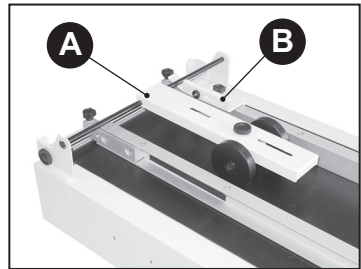

2. Check the stacker alignment. It should be level and, when positioned against the Inserter, the docking studs on the stacker should fit into the cut-out on the Inserter.

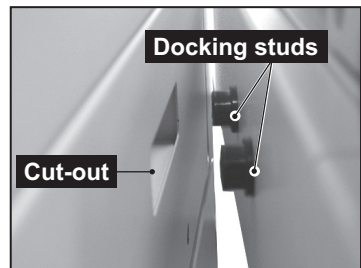

2 • Operation

If not correct, loosen the height adjustment knobs (C) on each leg in turn and readjust the stacker height.

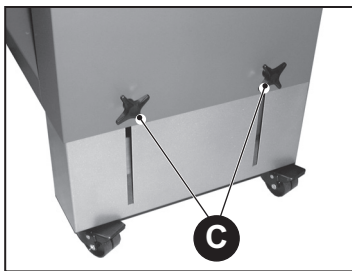

3. Position the stacker as close to the Inserter output as possible and centered with the output. When positioned correctly, lock all four castors.

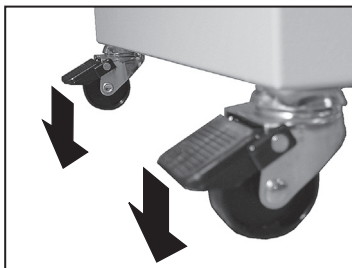

Operation in In Line mode with the DI875 Inserter

1. Place one envelope on the belt.
2. Center the side guides around the middle, approx. 1/4" (6mm) wider than the envelope. Use the front and rear scales to simplify the centering.
3. Adjust the idler wheel position; place an envelope with the trailing edge under the black shaft, slide the idler wheels so that they align with the leading edge of the envelope.

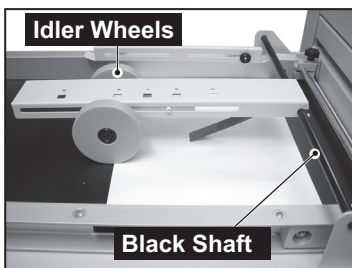

4. Read the safety information on page 1-1, then connect the belt stacker to the power supply and turn ON.

5. Set the belt speed to maximum.

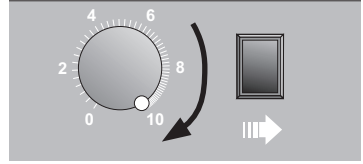

6. Start the DI875 system.

7. Adjust the envelope overlap by moving the start sensor. When the sensor is moved away from the inlet the distance between the envelopes will be larger, and vice versa. (Illustrations below show sensor setting with idler wheels removed for clarity).

Keep the step as small as possible without envelopes building up too much. That way you can optimize the belt capacity!

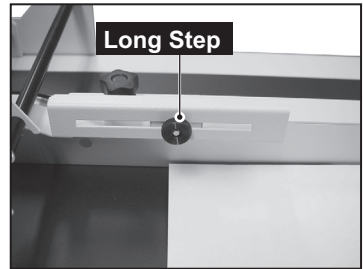
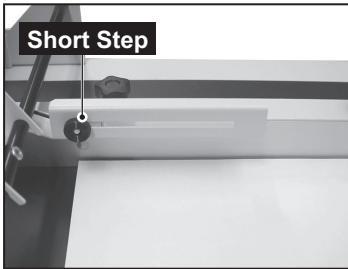

8. Reduce the belt speed until the motor runs continuously.

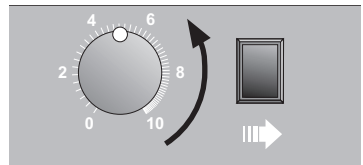

2 • Operation

Use with the DI900/DI950 Inserters

The belt stacker can be used in Right Angled or In Line configuration with the DI900/DI950 Inserters.

There are two setups for In Line operation: One for 'letters' (e.g. #10) sized envelopes, and another for 'flats' (e.g. #9) sized envelopes. In Line mode is essential for running 'flats'.

Right Angled setup and operation is described below. In Line setup and operation is described on page 2-22 (for 'letters') and page 2-25 (for 'flats').

Setup of Right Angled mode with DI900/DI950 Inserters

The illustration below shows the belt stacker correctly docked to the DI900/DI950 Inserter in a right angled orientation.

Follow the steps to correctly set up the stacker:

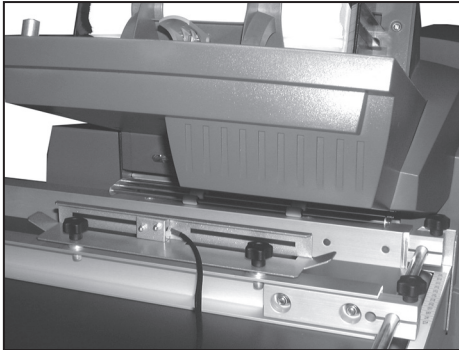

1. The exit roller bridge (A) should already have been installed to the Inserter output.

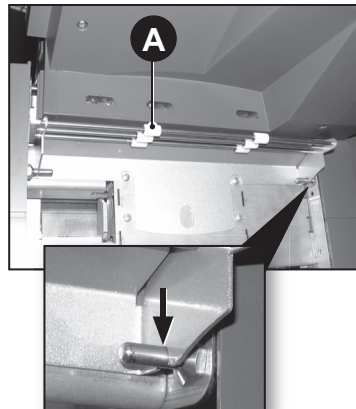

Make sure the bridge assembly is correctly located onto its mounting studs.

2. Loosen the front and rear end knobs **(B)** of the side guide **closest to the inserter output** and move the side guide as far open (in the direction of the arrow) as it will go.

Retighten the front and rear end knobs.

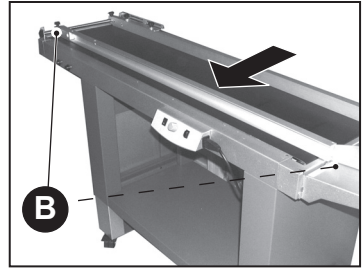

3. Check the stacker alignment. The top of the side guide should fit into the cut-out on the exit roller bridge assembly.

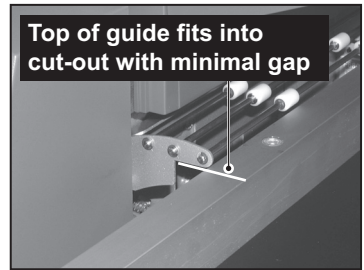

If necessary, loosen the height adjustment knobs **(C)** on each leg in turn and readjust the stacker height.

Alternatively, if the Inserter is on a height adjustable table, the table can be adjusted to achieve the correct height setting.

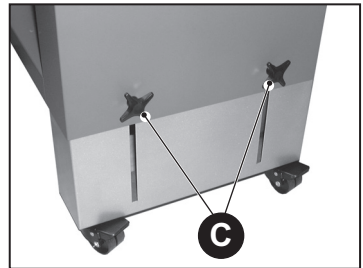

4. Position the stacker against the Inserter, making sure the side guide fits **FULLY** into the exit roller bridge cut-out.

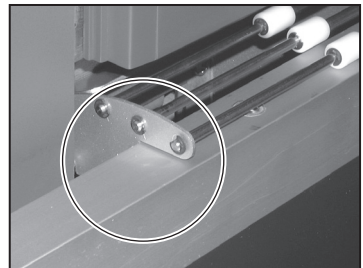

2 • Operation

- When positioned correctly, lock all four castors.

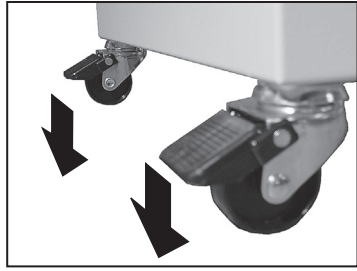

- For right hand operation, the sensor and sensor bracket (D) should be installed as shown in the picture. Make sure there is a spacer (E) between the bracket and stacker side guide at each knob position.

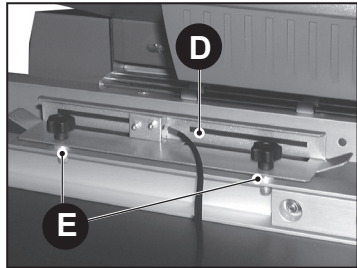

For left hand operation the parts are installed mirrored.

Operation in Right Angled mode with DI900/DI950 Inserters

- Place one envelope on the belt.
- Loosen the front and rear end side guide knobs (A) of the side guide **with the sensor bracket** only.

Make sure the side guide rests on the belt!

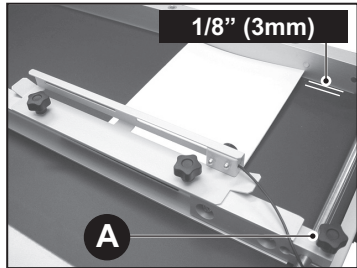

- Adjust the side guide to give a clearance of about 1/8" (3mm) and retighten the front and rear end side guide knobs.

Make sure the side guides are parallel!

- Read the safety information on page 1-1, then connect the belt stacker to the power supply and turn ON.

5. Set the belt speed to maximum.
6. Start the DI900/DI950 system.

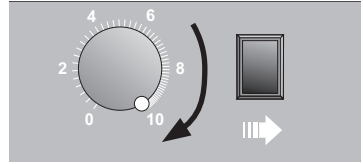

7. Adjust the envelope overlap by moving the start sensor. When the sensor is moved away from the inlet the distance between the envelopes will be larger, and vice versa.

Keep the step as small as possible without envelopes building up too much. That way you can optimize the belt capacity!

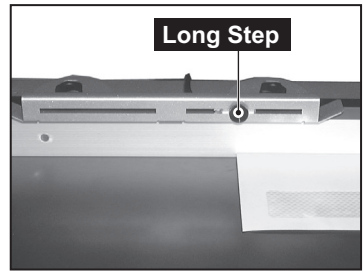
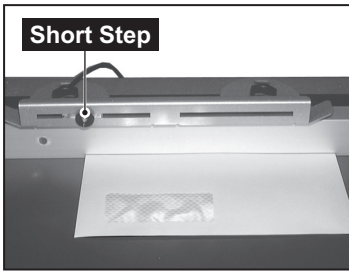

8. Reduce the belt speed until the motor runs continuously.

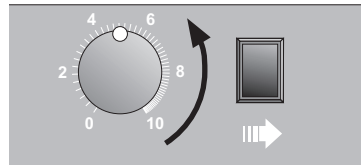

2 • Operation

Setup of In Line mode with DI900/DI950 Inserters and 'letter' sized envelopes

The illustration below shows the belt stacker correctly docked to the DI900/DI950 Inserter in the In Line orientation running 'letters'.

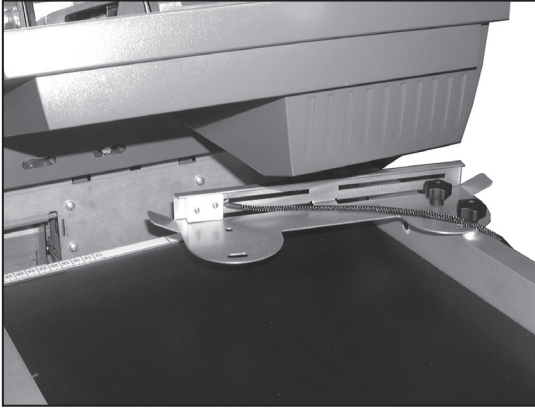

Use of the stacker in this mode allows the DI900/DI950 'Flats' box stacker to remain in use as shown.

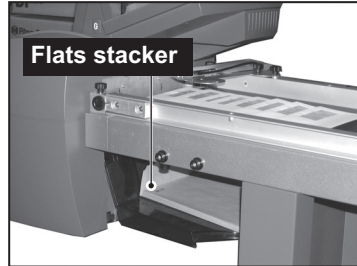

Follow the steps to correctly set up the stacker:

1. Check that the in line sensor bracket (A) is installed as shown, using the two knobs (B) with a spacer between the bracket and stacker side guide at each knob position.

Initially, position the sensor at the end of its slot and pivot the bracket fully counter-clockwise, as shown by the arrow.

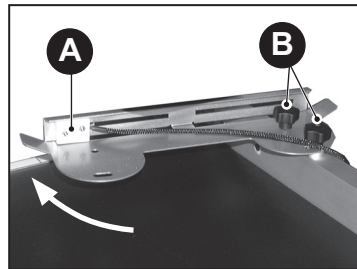

2. Check the stacker alignment. It should be level and the height of the stacker belt should be set to correspond with the **upper** mark on the decal installed to the Inserter exit area. Place a ruler onto the belt, as shown, to aid the height setting.



If necessary, loosen the height adjustment knobs (C) on each leg in turn and readjust the stacker height.

Alternatively, if the Inserter is on a height adjustable table, the table can be adjusted to achieve the correct height setting.

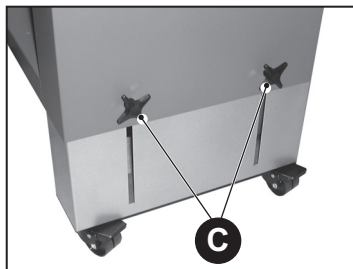

3. Position the stacker against the output end of the Inserter, **centered** with the output. Make sure the stacker is positioned firmly against the Inserter covers.

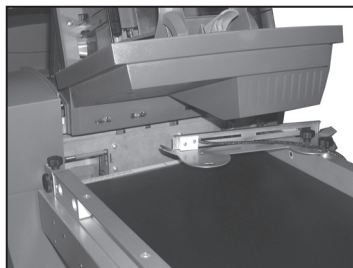

4. When positioned correctly, lock all four castors.

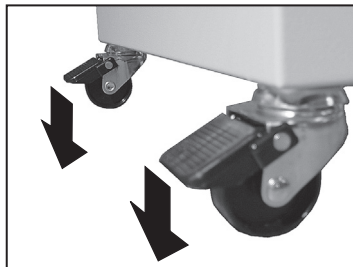

2 • Operation

Operation in In Line mode with the DI900/DI950 Inserters ('letter' sized envelopes)

1. The stacker side guides will have been locked wide open by your installing engineer as this configuration does not need the side guides to control envelope stacking.
2. Read the safety information on page 1-1, then connect the belt stacker to the power supply and turn ON.

3. Set the belt speed to maximum.

4. Start the DI900/DI950 system.

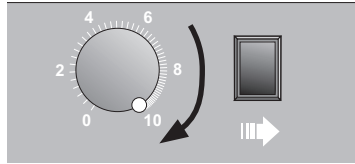

5. If envelopes leaving the Inserter hit the sensor bracket, or if the envelope overlap is incorrect, you can adjust the start sensor position.

When the sensor is moved away from the Inserter, the distance between the envelopes will be larger, and vice versa.

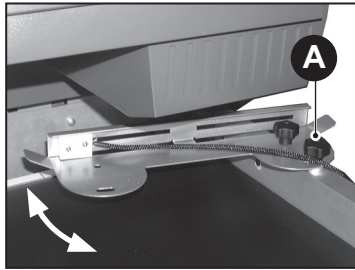

To adjust the sensor, loosen knob (A), pivot the sensor bracket and retighten the knob.

Keep the step as small as possible without envelopes building up too much. That way you can optimize the belt capacity!

6. Reduce the belt speed until the motor runs continuously.

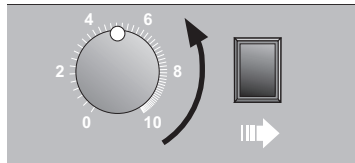

Setup of In Line mode with DI900/DI950 Inserters and 'flat' sized envelopes

The illustration below shows the belt stacker correctly docked to the DI900/DI950 Inserter in the In Line orientation running 'flats'.

Follow the steps to correctly set up the stacker:

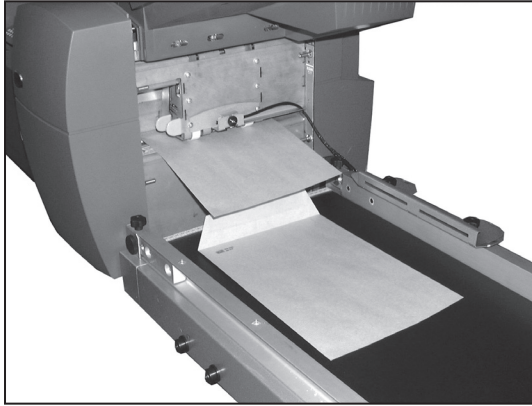

1. Check the stacker alignment. It should be level and the height of the stacker belt should be set to correspond with the **lower** mark on the decal installed to the Inserter exit area. Place a ruler onto the belt, as shown, to aid the height setting.

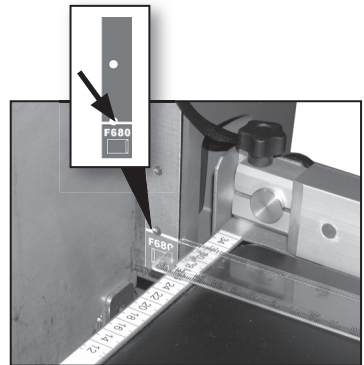

If necessary, loosen the height adjustment knobs (**A**) on each leg in turn and readjust the stacker height.

Alternatively, if the Inserter is on a height adjustable table, the table can be adjusted to achieve the correct height setting.

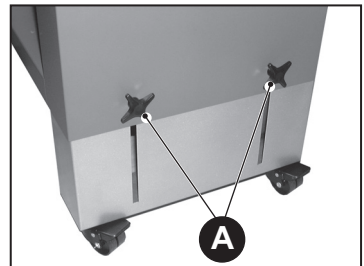

2 • Operation

2. The sensor should already be installed into the slot on the magnetic bracket.

Route the sensor cable back underneath the nuts attached to the sensor body and through the cable cut out on the bracket.

Ensure the bottom face of the sensor is as close as possible and parallel to the lower face of the magnetic bracket.

Make sure the knob (B) is tight.

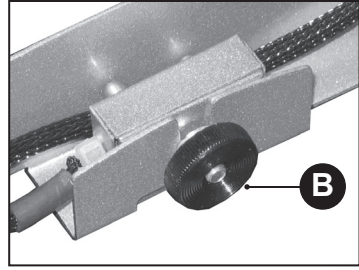

3. Fit the magnetic bracket (C). Make sure it locates correctly over the screws (D).

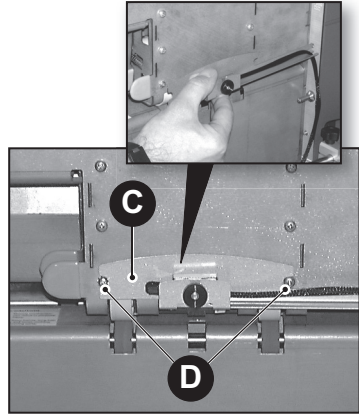

4. Position the stacker against the output end of the Inserter, **centered** with the output. Make sure the stacker is positioned firmly against the Inserter covers. Also make sure the cable (E) is routed clear of the envelope exit.

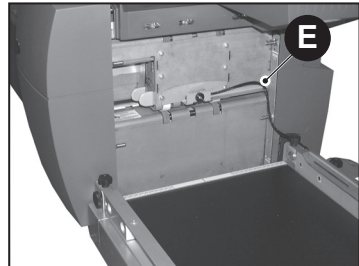

5. When positioned correctly, lock all four castors.

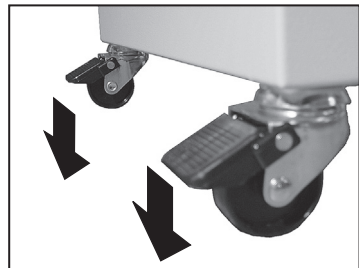

Operation in In Line mode with the DI900/DI950 Inserters ('flats' sized envelopes)

1. The stacker side guides will have been locked wide open by your installing engineer as this configuration does not need the side guides to control envelope stacking.
2. Read the safety information on page 1-1, then connect the belt stacker to the power supply and turn ON.

3. Set the belt speed to maximum.

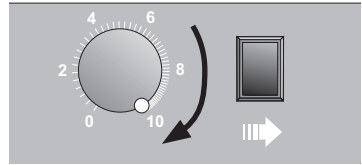

4. Start the DI900/DI950 system.

5. Reduce the belt speed until you obtain the desired envelope overlap.

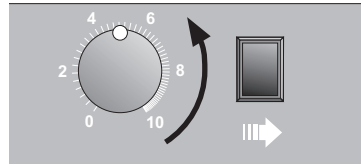

Keep the overlap as small as possible without envelopes building up too much. That way you can optimize the belt capacity!

2 • Operation

The Tandem Belt Stacker

A particular configuration of the stacker is available for the DI900/ DI950 Inserters that allows automatic stacking of 'Letters' and 'Flats' simultaneously. The stacker consists of two stacker units mounted onto one set of legs or one table at the correct vertical spacing to receive 'Letter' and 'Flats' output from the Inserter.

Use the 'Letters' In Line instructions beginning on page 2-22 to setup and operate the top stacker unit. Use the 'Flats' In Line instructions from page 2-25 for the lower stacker unit.

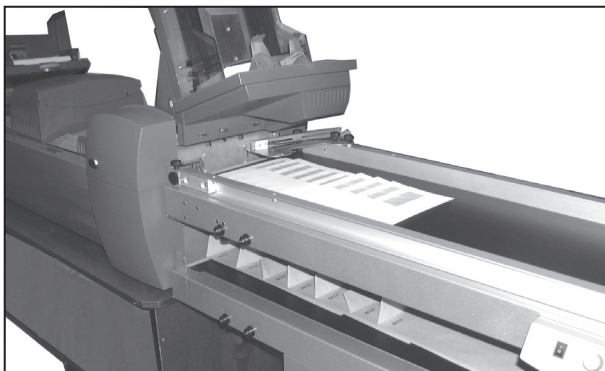

Use of the Belt Stacker with Other Equipment

The belt stacker can be used with equipment other than inserters (for example, address printers).

Dependent on the equipment being used and the material being run, either a Right Angled or an In Line configuration will be used.

Full details of your setup will be given by your installing service representative and will vary in detail based on your application.

However, if you need a reminder, refer to the sections of this guide covering the DI800 series Inserter (beginning on page 2-4). These sections will describe basic setup and operation of each configuration.

Troubleshooting

Configuration	Possible Cause	Remedy
Envelopes get stuck in the inlet area or feed poorly onto stacker		
All	Belt speed too low, material builds up and gets stuck	Increase belt speed
All	Step length too small	Increase step length
All	Side guides set too narrow	Adjust side guides
All	The incoming envelope catches on the previous envelope's window	Increase belt speed and step length, so that the incoming envelope won't hit the previous envelope window
All	Material slips in underneath side guide and gets stuck	Loosen side guide knobs, press side guide down and tighten knobs
All	Stacker alignment incorrect	Adjust height of stacker legs and/or position stacker against inserter as described in chapter 2
Right angled configurations	Front side guide not set correctly	Adjust front side guide as close to inserter as possible
DI875 only	Entry guide brushes set too tight/low	Readjust brushes upwards
DI900/DI950 'Flats'	Magnetic sensor bracket positioned incorrectly	Check sensor bracket is located correctly
DI900/DI950 Right angled configuration	Exit roller bridge not transporting envelopes correctly	Check exit roller bridge is correctly located onto its mounting pins

3 • Reference

Configuration	Possible Cause	Remedy
Envelopes hit sensor bracket		
Right angled configurations	Rear (sensor) guide set too close to inserter	Move rear (sensor) guide back
DI900/DI950 In line 'Letters'	Adjustable sensor bracket too close to inserter	Pivot sensor bracket slightly further back
Material doesn't transport all the way to the stacker end stacking tray		
All	Side guides too narrow or funneled	Check side guides are parallel and have correct clearance
All	Step too big, material slips on belt because of insufficient weight	Reduce step, reduce belt speed
Material topples over on the belt, even with low numbers of items		
All	Step length too big	Reduce step, reduce belt speed
All	Side guides not parallel or too tight	Check side guides are parallel and have correct clearance

Service

Service for your belt stacker is available throughout the world.

Should you have questions about your belt Stacker, or require service or assistance with your particular application, please call Pitney Bowes.

A service maintenance contract is available to keep your belt Stacker (as well as your entire Inserting system) in top condition at nominal cost. Contact Pitney Bowes for details (see the *Pitney Bowes Contact List* at start of this guide for contact information).

Specifications

Equipment Specifications:

Standard Features	Variable speed, Adjustable overlap of media, Clear-deck switch, Universal power inlet, Lockable castors on all four feet, Aligning studs for Inserter DI875
Capacity	With a minimum insert in the envelope: 6"X 9" up to a maximum of 2,500 envelopes 9"X12" up to a maximum of 1,500 envelopes #10 up to a maximum of 1,200 envelopes
Table Height	Adjustable 25"– 42' (635mm –1060mm) (only on models with height adjustable legs)
Width	17-1/4" (440mm), incl. 2" (50mm) for control unit
Length	70-1/4" (1785mm), incl. end stacking plate 13-3/4" (350mm)
Weight	128 lbs. (58kg)
Power	100-240VAC \pm 10%, 50/60 Hz, 1A Power consumption 70W Heat emission 70 Joule/s (240 Btu/hr)
Compliance	UL Listed for the United States and Canada

Material Specifications:

The side guides are adjustable between 4-1/2" (115mm) and 14" (357mm).

3 • Reference



Engineering the flow of communication™

1 Elmcroft Road
Stamford, Connecticut 06926-0700
www.pb.com

5500 Explorer Drive
Mississauga, Ontario L4W5C7
www.pitneybowes.ca

For Service or Supplies

A large, empty rectangular box with a thin blue border, intended for a service or supply request.

PB Form SV40231 Rev. A 5/05

©2005 Pitney Bowes Inc.
All Rights Reserved
Printed in the USA or Canada



Printed on recyclable paper



★ S V 4 0 2 3 1 R E V A ★