



Shipping & Mailing
Postage Meters

SendPro® C Lite, SendPro® C, SendPro®+

PCN 8H00

Operator Guide

US English Edition
SV63317 Rev.P
January 04, 2024

©2024 Pitney Bowes Inc.

All rights reserved. This book may not be reproduced in whole or in part in any fashion or stored in a retrieval system of any type or transmitted by any means, electronically or mechanically, without the express written permission of Pitney Bowes.

The use of this information by the recipient or others for purposes other than the training of customers on Pitney Bowes equipment may constitute an infringement of intellectual property rights of Pitney Bowes, and Pitney Bowes assumes no responsibility for any such use of the information.

We have made every reasonable effort to ensure the accuracy and usefulness of this manual. However, we cannot assume responsibility for errors or omissions or liability for the misuse or misapplication of our products.

Except as provided in writing, duly signed by an officer of Pitney Bowes, no license either express or implied, under any Pitney Bowes or third party's patent, copyright or other intellectual property rights is granted by providing this information.

PB Postage™ is a trademark of Pitney Bowes Inc.

Table of Contents

1 - Quick start guide

Finding the Product Code Number (PCN) and serial number	10
Navigating the Home screen	11
Printing a shipping label or printing postage on an envelope	14
Printing a shipping label	16
Enabling Cost Accounts for shipping labels	21
Adding a Print on Envelopes account	21
Navigating the Print on Envelopes app	22
Preventing envelope feeding problems	23
Sending a First-Class Mail envelope	24
Sending a large First-Class® envelope	25
Sending Certified Mail	26
Sending an international letter	27
Sending mail using a Certificate of Mailing	27
Using USPS special services	29
Updating postal rates or software for printing on envelopes	29
Adding or refilling postage for printing on envelopes	30
Sealing envelopes when you print postage	31
Filling the moistener tank	33
Replacing the ink cartridge	34
Printing a test pattern	36
Adding favorite apps	37
Creating presets for printing postage	38
Selecting a preset for printing postage	39

2 - Connectivity information

Setting up a wired network connection	42
Setting up a wireless (Wi-Fi) network connection	45

Connecting to a hidden Wi-Fi network	45
Forgetting a Wi-Fi network	47
Checking your network connection	49
Finding the MAC address for wired and wireless networks	49
Setting up a Proxy server	53

3 - Managing your Device

Creating or disabling the security PIN	58
Adjusting time zone and scale location code	59
Adjusting display brightness	59
Adding favorite apps	60
Setting up the Energy Saver	61
Using USPS Informed Delivery	61
Installing the SendPro C Lite, SendPro C, SendPro+	61
Installing a scale	71
Uploading system logs	72

4 - Printing Shipping Labels

Signing in to and out of the Create Shipping Labels app	75
Printing a shipping label	75
Comparing rates when printing a shipping label	82
Creating a new sender address for shipping labels	89
Editing the sender address for shipping labels	89
Printing an international shipping label	90
Printing a USPS return shipping label	101
Printing a USPS scan form	101
Reprinting a USPS, UPS or FedEx shipping label	102
Canceling a UPS or FedEx shipping label	103
Getting a USPS refund for a shipping label	103

5 - Managing Shipping Labels

Using the Address Book	106
Changing the default refill amounts for shipping labels	106
Turning on address autofill for shipping labels	106
Adding new addresses to the shipping labels Address Book	107
Enabling Cost Accounts for shipping labels	107
Refilling postage for shipping labels	108
Setting an alert when shipping label postage refill is pending	109
Setting up your FedEx account	110
Setting up your UPS account	111
Setting up default printing options	112
Managing email notifications for shipping labels	113
Setting the default address for USPS return labels	114
Determining how you spend your shipping labels postage	114
Removing funds	114

6 - Printing on envelopes

Navigating the Print on Envelopes app	118
Checking the available funds for printing postage	119
Adding or refilling postage for printing on envelopes	121
Sending a First-Class Mail envelope	122
Sending a large First-Class® envelope	123
Sending Certified Mail	124
Sending an international letter	125
Sending mail using a Certificate of Mailing	125
Advancing the date	127
Printing postage without a date for pre-printed mailpieces	127
Printing additional postage	128
Re-dating your mail	129
Using USPS special services	130
Entering the weight manually when printing postage	130
Using the scale when printing postage	131
Sealing envelopes without printing postage	132
Sealing envelopes when you print postage	133
Zeroing the scale	135
Adding insurance to your mail	136

Adding a graphic to your envelope or tape	137
Sending mail using Electronic Return Receipt (ERR)	137
Getting a USPS refund for damaged or incorrectly printed mail	138
Creating a custom text message for your mail	139
Adding a custom text message to your envelope or tape	141
Editing or deleting a custom text message	143
Printing a graphic without printing postage	145
Adding an inscription	146
Printing only the date and time	146

7 - Managing Printing on Envelopes

Confirming your meter update	149
Changing the default refill amount for printing postage	149
Uploading postage transactions	150
Clearing or resetting the number of mailpieces sent	151
Performing USPS postal inspections for postage printing	151
Updating postal rates or software for printing on envelopes	151
Confirm the effective date for postal rates	152
Setting the low funds warning for printing postage	153
Setting up a mailer ID	153
Updating the ZIP code	154
What is Accounting	154
Turning Print on Envelopes account passwords on or off for printing postage	155
Adding a Print on Envelopes account	157
Editing an account	157
Making an account inactive	158
Deleting an account	158
Creating presets for printing postage	159
Viewing presets for printing postage	160
Selecting a preset for printing postage	160
Modifying presets for printing postage	160
Setting the default preset timer	161

8 - View and Print Reports

Viewing a receipt when refilling postage	164
Viewing the total spent on printing postage	164
Viewing the refill history for printing postage	164
Printing a funds report	164
Running account reports	165
Emailing an account report	166
Setting the report period for an account	167
Setting the account report preferences	168
Creating a shipping report	169
Creating a USPS shipping label refund report	169

9 - Maintenance

Checking the postage print quality	172
Printing a test pattern	172
Checking the ink level	173
Replacing the ink cartridge	174
Changing the ink waste pad	176
Cleaning the printhead	178
Installing the printhead	183
Cleaning the moistener brush and wick assembly	188
Filling the moistener tank	192
Avoiding envelope sealing issues	193
Preventing envelope feeding problems	194
Moving the SendPro C Lite, SendPro C, SendPro+	195

10 - Supplies

Ordering supplies	198
-------------------------	-----

11 - Device Information

USPS requirements	200
-------------------------	-----

Key in Postage	200
Sections of the meter impression	200
Finding the SendPro application software version	201
Postal Security Device	202
Parts of the SendPro C Lite, SendPro C, SendPro+	202
Connections on the back	203
Specifications	204
Material specifications	207

12 - Contacting Pitney Bowes

Contacting Pitney Bowes	212
-------------------------------	-----

13 - Safety

Lithium Ion Battery	215
Agency Compliance Information	215
Important Safety Notes	215
Note for California Customers Only on all Models	217

14 - Third party software

Third party software	219
----------------------------	-----

1 - Quick start guide

In this section

Finding the Product Code Number (PCN) and serial number.....	10
Navigating the Home screen.....	11
Printing a shipping label or printing postage on an envelope.....	14
Printing a shipping label.....	16
Enabling Cost Accounts for shipping labels.....	21
Adding a Print on Envelopes account.....	21
Navigating the Print on Envelopes app.....	22
Preventing envelope feeding problems.....	23
Sending a First-Class Mail envelope.....	24
Sending a large First-Class® envelope.....	25
Sending Certified Mail.....	26
Sending an international letter.....	27
Sending mail using a Certificate of Mailing.....	27
Using USPS special services.....	29
Updating postal rates or software for printing on envelopes.....	29
Adding or refilling postage for printing on envelopes.....	30
Sealing envelopes when you print postage.....	31
Filling the moistener tank.....	33
Replacing the ink cartridge.....	34
Printing a test pattern.....	36
Adding favorite apps.....	37
Creating presets for printing postage.....	38
Selecting a preset for printing postage.....	39

Finding the Product Code Number (PCN) and serial number

In order to find the correct information for your device, you need to know the model number.

To locate the **(1) Product Code Number (PCN)** and the **(2) 7-digit serial number**, check the label on the rear of the device or under the display cover. The serial number appears as zeros here for security reasons.

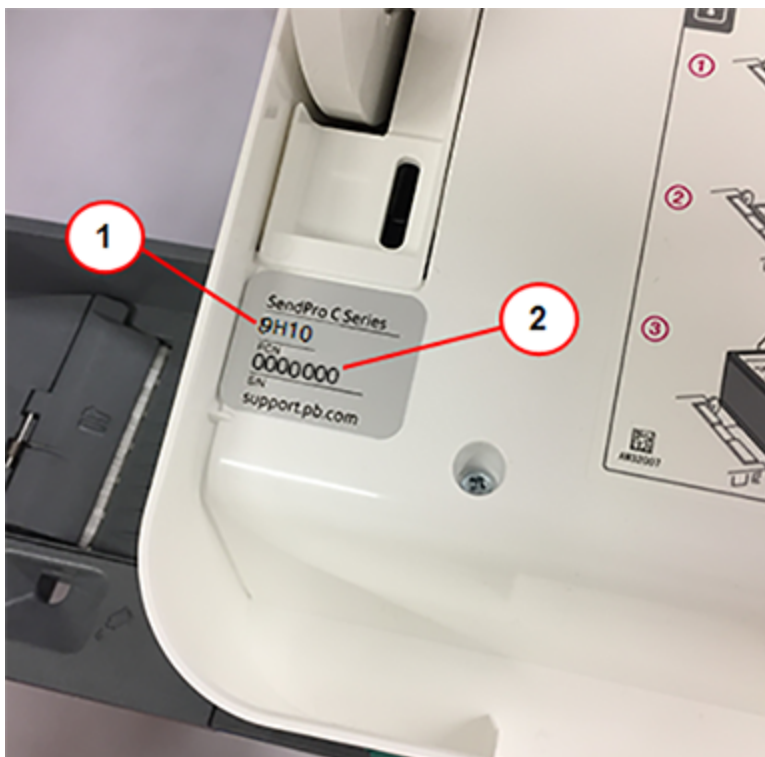

Navigating the Home screen

You can create a shipping label or print postage from the Home screen on the SendPro C Lite, SendPro C, SendPro+.

Creating shipping labels or printing on envelopes

Tap **Print on Envelopes** to print postage for envelopes and post cards. Tap **Create Shipping Labels** to create a shipping label for important large envelopes or packages using USPS, UPS®, or FedEx®.

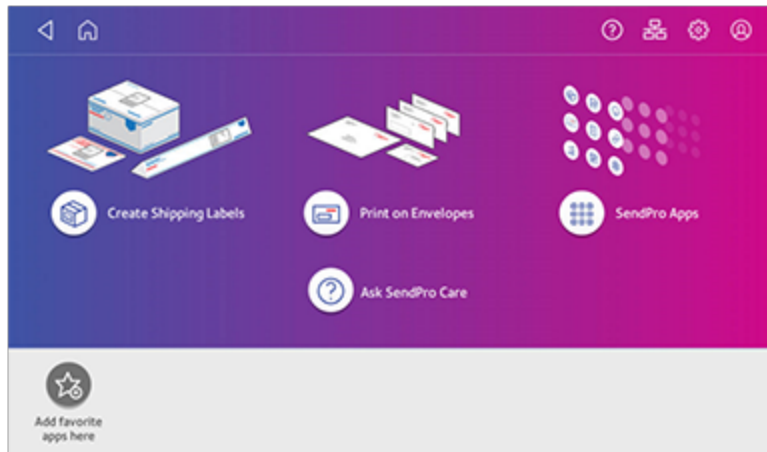

Using SendPro Apps

Tap on **SendPro Apps** to access a variety of apps to support and enhance your device.

For example, you can:

- Check for rates and updates (Rates and Updates)
- Get a history of shipping labels created (Shipping History)
- Check the status of your network connection (Network Connection).

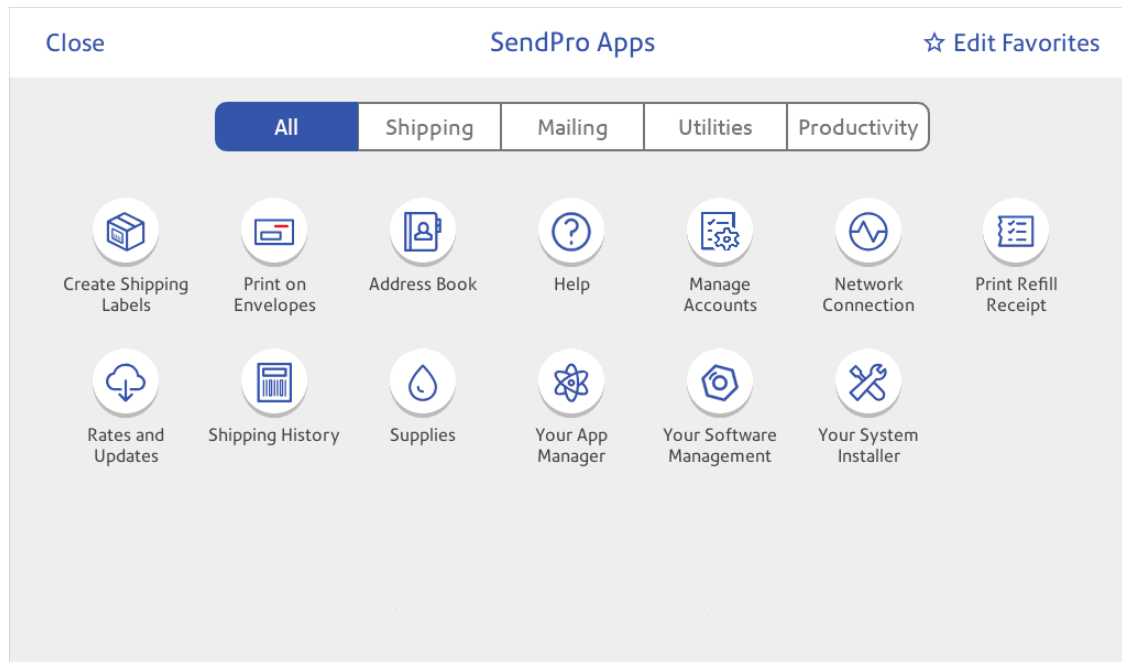

You can also add your most frequently used apps to a list of favorites appearing along the bottom of the Home screen.

Getting help on your device

Tap **SendPro Care** on the Home screen to get information about your device

The SendPro Care app automatically recognizes your device issues and provides recommendations for resolving them. The app also provides:

- Real-time predictive updates, diagnostic, error notifications, and offers.
- Solutions to resolve the issue.
- Essential tools and guides.
- Voice (mobile app) and text search to resolve issues quickly.
- Product health management and tracking.
- Account balances and case status.
- Spending and saving insights to track your budget more effectively.

To learn how to use the SendPro Care app, tap **i How to use** on the main page of the app.

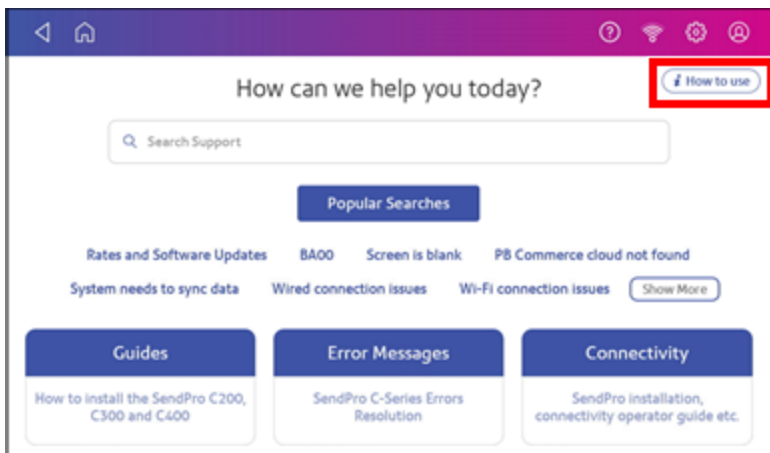

The toolbar

The toolbar appears at the top of every screen. It allows you to view and change settings for your device.



1. Back - Return to the previous screen.
2. Home - Return to the Home screen from anywhere in Create Shipping Labels or Print on Envelopes.
3. Tap the question mark in the toolbar to open the SendPro Care app.
4. Network - View the current network type (wireless or Ethernet) and status and strength (for wireless connection). Allows you to turn wireless connection on or off. The icon here represents a wireless connection.

5. **Settings** - View or change your device and app settings. This includes adjusting the screen brightness, setting sound notification levels, and viewing wireless or Ethernet connection information. For **Print on Envelopes**, this includes setting the default postage refill amount, installing external scales and performing maintenance. For shipping labels, this includes managing your carrier accounts and setting up your shipping label printer default values.
6. **Profile** - View your profile (name and email for shipping label account), log out, or lock your SendPro C Lite, SendPro C, SendPro+.

Printing a shipping label or printing postage on an envelope

You can either create a shipping label or print postage on an envelope. For a shipping label, tap **Create Shipping Labels** on the Home screen. For postage, tap **Print on Envelopes** on the Home screen.

Use Create Shipping Labels to get the best pricing, free tracking, and detailed delivery history for USPS package services. You can also send via UPS® or FedEx®. The packaging options and benefits are almost identical.

Use Create Shipping Labels for the following

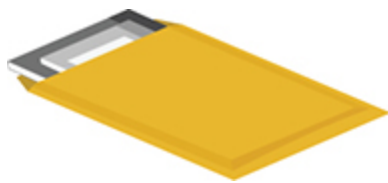

Thick envelopes

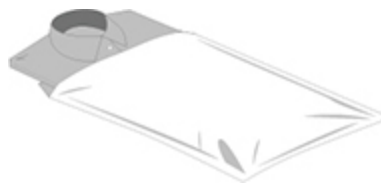

Poly mailers



USPS flat rate envelopes



USPS non flat rate envelopes



Boxes

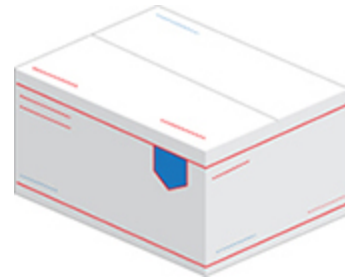

USPS flat rate boxes

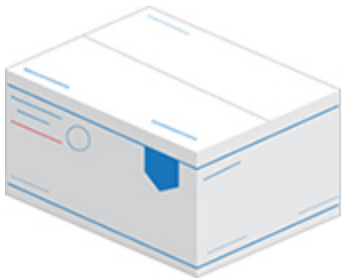

USPS non flat rate boxes



Tube

Use Print on Envelopes for the following



Standard envelopes and postcards



Large envelopes

Printing a shipping label

Use Create Shipping Labels to get the best pricing, free tracking, and detailed delivery history for USPS package services. You can also send via UPS® or FedEx®. The packaging options and benefits are almost identical.

1. Tap **Create Shipping Labels** on the Home screen.
2. Tap the carrier you wish to use.

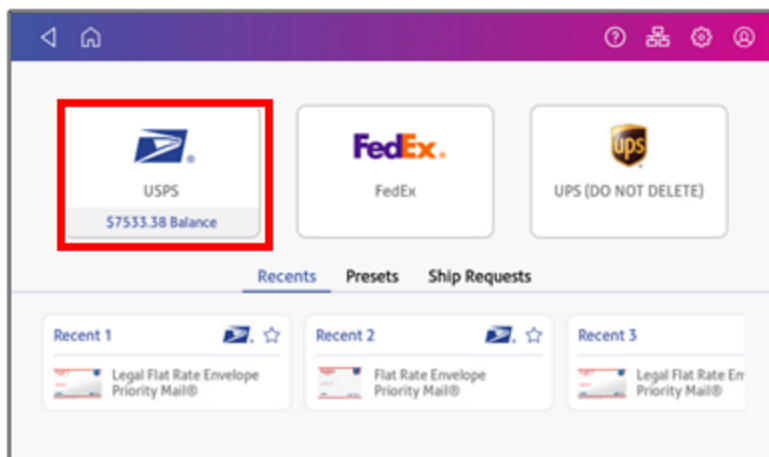

3. Verify that the sender address is correct. If not, tap on the **Sender** field and select a new address.

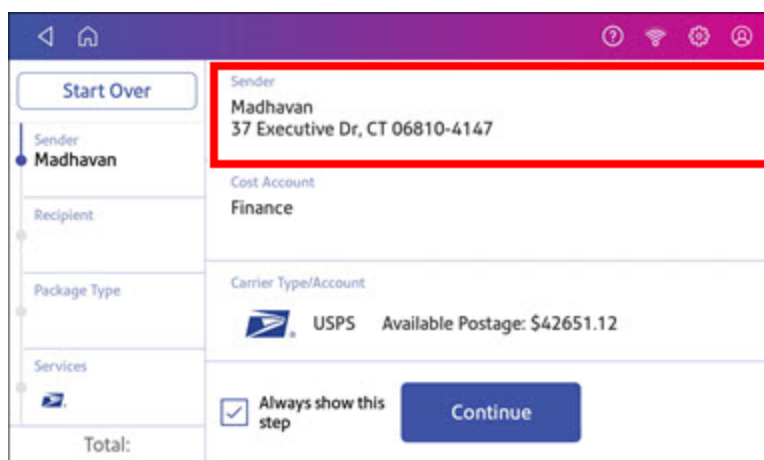

4. Select an account if cost accounts are enabled. Verify the selected cost account. Tap **Cost Account** and select an account to change or add the account..

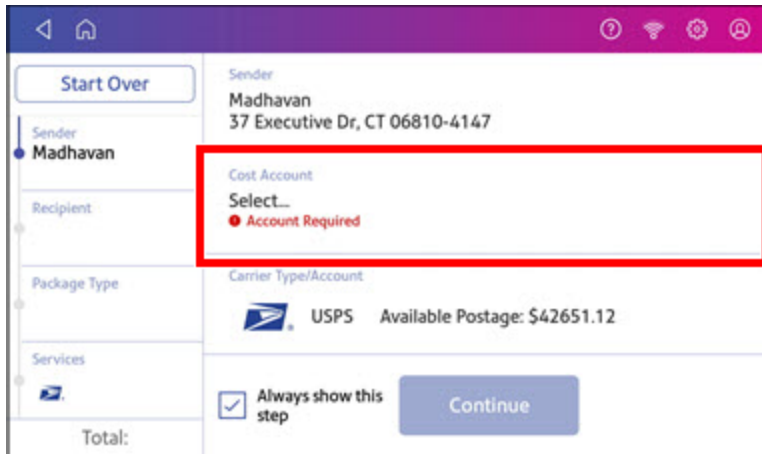

5. Tap **Continue**.

6. Enter the recipient address manually or tap **Address book** to select one from the address book.

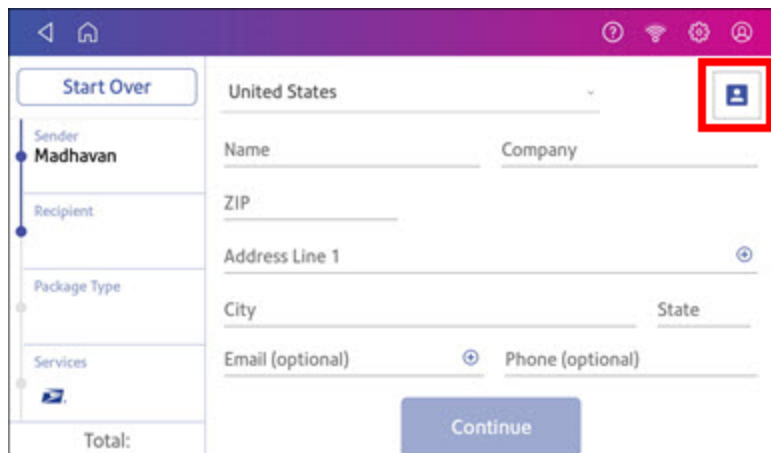

The screenshot shows the USPS shipping app interface. On the left, a vertical menu includes 'Start Over', 'Sender' (Madhavan), 'Recipient', 'Package Type', 'Services', and 'Total:'. The main area is for address entry, with 'United States' selected at the top. A red box highlights the 'Address book' icon in the top right corner. Below it are fields for 'Name' (with a 'Company' sub-field), 'ZIP', 'Address Line 1', 'City', 'State', 'Email (optional)', and 'Phone (optional)'. A 'Continue' button is at the bottom right.

7. Tap **Continue**.
8. Tap a package type.

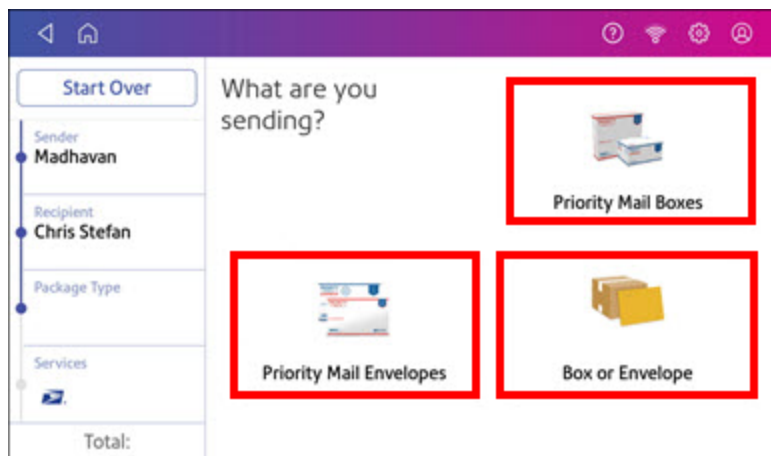

The screenshot shows the USPS shipping app interface with the question 'What are you sending?'. Three options are highlighted with red boxes: 'Priority Mail Boxes' (top right), 'Priority Mail Envelopes' (bottom left), and 'Box or Envelope' (bottom right). The left menu is updated to show 'Recipient' as 'Chris Stefan'. The 'Total:' field is at the bottom left.

9. Enter the dimensions and weight of the package:
 - Tap each dimension and enter a value. Tap the green check mark when done.
 - If you have an attached scale, place the package on the scale and tap **Weight**. Tap **Scale** and the weight appears. Tap **Apply**.
 - If you do not have a scale, tap **Weight** and enter the weight, then tap **Apply**.

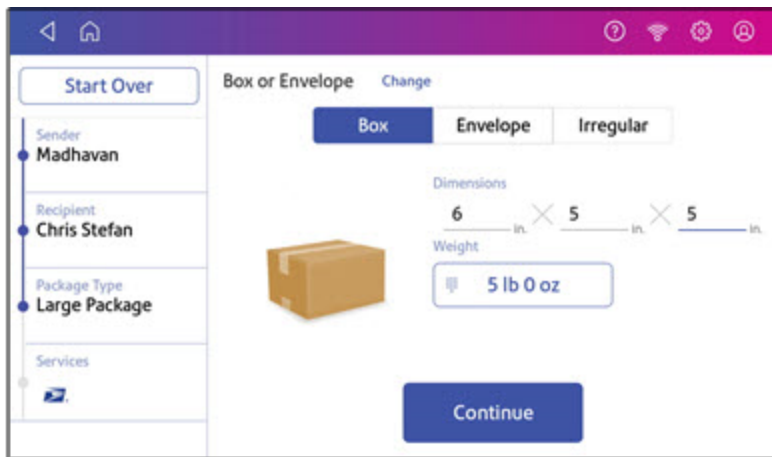

10. Tap **Continue**.
11. Tap the service you wish to use.

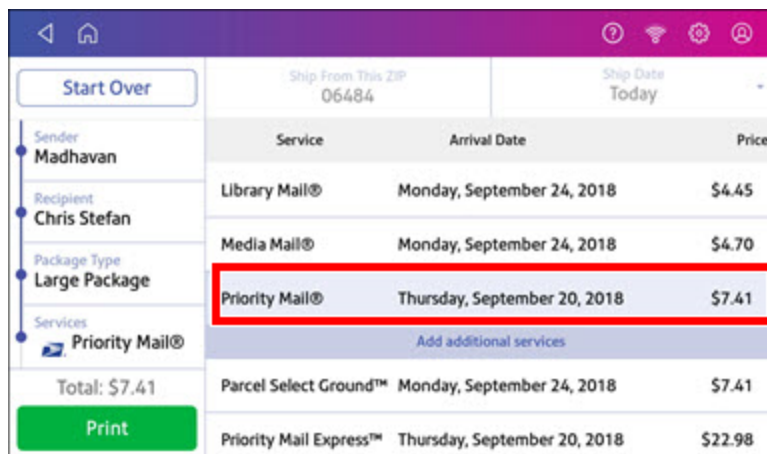

12. To add additional services, tap **Add additional services**. If you are not adding any extra services, go to step 14.

Service	Arrival Date	Price
Library Mail®	Monday, September 24, 2018	\$4.45
Media Mail®	Monday, September 24, 2018	\$4.70
Priority Mail®	Friday, September 21, 2018	\$7.41
Add additional services		
Parcel Select Ground™	Monday, September 24, 2018	\$7.41
Priority Mail Express™	Thursday, September 20, 2018	\$22.98

Total: \$7.41

Print

13. Select the desired services and tap **Apply**.

Cancel Extra Services

- Signature Confirmation™
- Insurance
- Registered Mail™
- Registered Restricted Delivery
- Registered Insured Restricted Delivery
- Fragile
- Collect on Delivery

Priority Mail®
Total: \$9.96

Apply

14. To print the label, tap **Print**.

15. On the Label Options screen, tap **Format** and select the printer format.

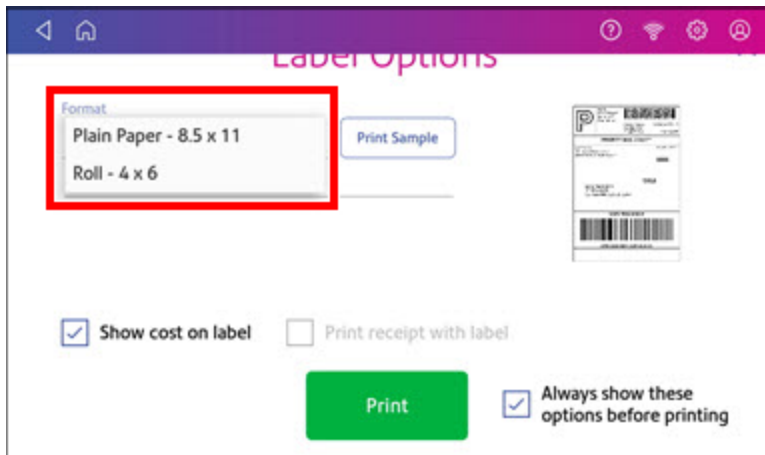

16. (Optional) Tap **Print Sample** to print a sample label.
17. Tap **Print** again and the label prints.
 - You may need to enter the Sender and Recipient's phone number, as it is required for some services.
18. The carrier screen reappears.

Enabling Cost Accounts for shipping labels

Cost Accounts help you keep track of where you're spending your money on postage by allowing you to assign shipping label costs. You can also assign a Cost Account for postage refills.

The Cost Accounts feature is enabled via the SendPro Online® or PitneyShip™ shipping solution. Please access the SendPro Online or PitneyShip web application on your computer where you can also view Cost Accounts information.

Adding a Print on Envelopes account

You can add a Print on Envelopes account to track your costs for printing postage on envelopes. This is different from your PB account which is used to fund your postage or shipping label costs.

Accounting is a feature that is optional and needs enabling if you want to use it. Contact your Pitney Bowes Sales Representative for information about options and pricing.

1. Tap **SendPro Apps** on the Home screen.
2. Tap **Manage Accounts**.
3. Tap **Create new account**.
4. Tap **Create a new account** for a new account.
5. Enter the account name in the Enter account name field. Account names can be up to 75 characters long.
If the keyboard does not pop up, tap the line in the gray box.
6. Enter a unique code in the Code field to identify each account. Codes can be alphanumeric. Codes help you locate accounts more easily.
7. You can use the optional fields, such as:
 - **Description** - Enter a description of the account up to 150 characters.
 - **Password** - Tap **Password** to add a password for an account.
 - Passwords are case sensitive, can be alphanumeric, and must be four characters in length. If you do set a password, you need to enter it to print mail.
8. Ensure you set the status to active.
9. Tap anywhere on the screen outside of the fields when complete.
10. Tap **OK** to save. The name of the new account appears.
 - Tap **Create New Account** to create another account.
 - Tap **Add a Sub Account to this account** to add a sub account to the account you just created.
 - Tap **Done** if you do not need to create any more accounts.
11. Press the **back arrow** to return to the account list.

Navigating the Print on Envelopes app

The Print on Envelopes app is the starting point for printing postage on an envelope or a tape. It also allows you to change what you print.

To open the Print on Envelopes app, tap **Print on Envelopes**.

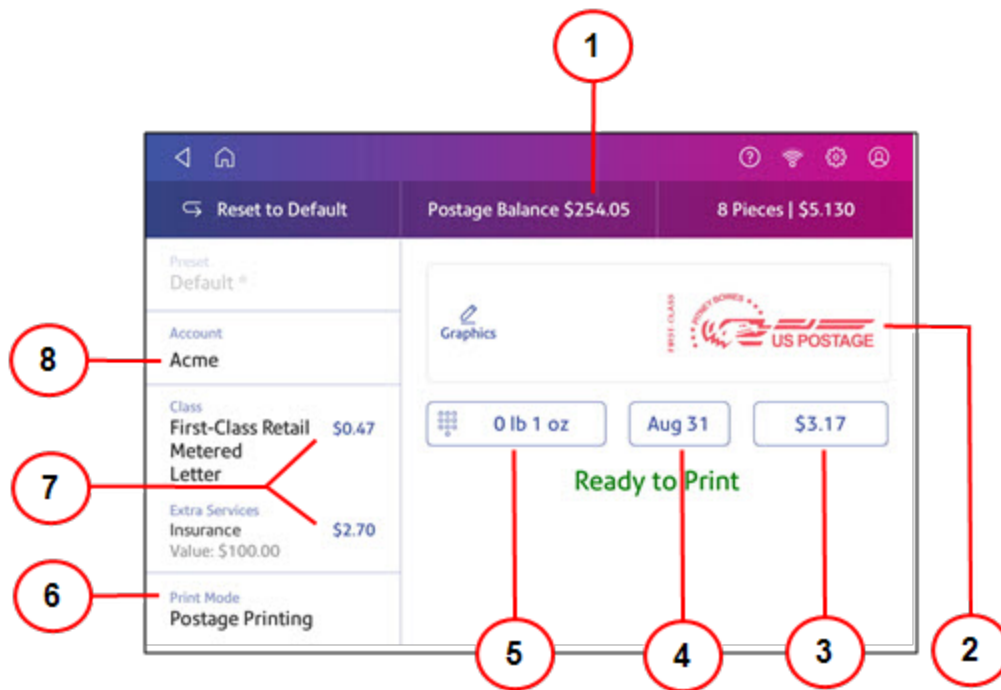

On this screen, you can:

1. View **Postage Balance** - View the balance of funds you have left in your device.
2. Preview or add **Graphic** - Tap **Graphic** to preview or add graphics.
3. View **Total postage amount** - View the total postage amount.
4. View **Date** - Tap the date to view the date options.
5. View **Weight** to view the weighing options. You can enter the weight manually or use a scale.
6. View **Print Mode** - View the available printing modes such as printing a graphic only, printing the date and time, or seal envelopes without printing postage.
7. View **Class** - Tap **Class** to view available postal classes and any extra services.
8. View **Account** - Tap **Account** to charge back postage to departments or clients. Run reports showing how you spent your postage over specific time periods. If you did not purchase Accounting, you will not see the Accounting option.

Preventing envelope feeding problems

Ensure you feed envelopes correctly to help prevent feeding problems.

Feeding mail

1. For your first envelope, hold the far edge of the envelope against the back wall of the feeder.
2. Slide the envelope into the feeder until you feel it touch the rollers. You hear the motor begin. Do not release the envelope until the feeder grabs it to pull it through the device.
3. You hear the motor continue to run for about 5 seconds once it prints postage on the envelope.
4. Continue to feed envelopes one at a time. Make sure you press the edge of each envelope against the back wall of the feeder and into the feeder until it touches the rollers.
 - Make sure the envelopes fully exit the feeder and do not pile up on the edge of the feeder.
 - If you are using a stacker, you may need to extend the stacker tray so that the envelopes exit the feeder completely.

Hold the envelope against the back wall to avoid skews

If you do not hold the envelope against the back wall, it can feed in crooked or skewed. A skewed envelope can either exit the device with no postage applied or cause a jam. The message Clear Paper Jam appears. This could deduct funds. Even a minor skew that may be difficult to see can cause a jam.

Preventive action

To prevent envelope feeding problems:

- Using a can of non-flammable compressed air, blow on the feed deck on the left side and work toward the transport deck on the right side. Make sure to remove all the dust and debris.

Sending a First-Class Mail envelope

First-Class Mail is an economical way to send mailpieces through the USPS. You can send standard postcards, letters, and large envelopes and small packages up to 15.99 ounces.

1. Tap **Print on Envelopes** on the Home screen.
2. If you have the accounting feature enabled, tap **Account** and select an account.
3. Tap **Class**.
4. Tap **Start Over** to show a list of all the available classes.
5. Tap **First-Class Retail Metered** for a First-Class Mail envelope.

6. Tap **Letter**.
7. Select any special services you wish to use.
8. Tap **Apply**.
9. Place the envelope on the scale. The weight appears.
10. Place the envelope or envelopes on the feed deck. Depending on the SendPro C model you have, feed the envelopes manually or tap **Start** to feed the envelopes.

Important: Your device will upload transactions if you have previously printed any mail. Once the upload completes, you see the message "Transaction upload status, Upload success" with a check mark. Tap the check mark.

Sending a large First-Class® envelope

Before you select a rate for a large envelope, you need to determine whether the mailpiece you are sending is a letter or large envelope according to the USPS.

If your mailpiece weighs more than 3.5 oz, the device automatically sets the class to Large Envelope regardless of the dimensions. If the mailpiece weighs less than 3.5 oz but has the dimensions of a large envelope, you need to manually select Large Envelope when you choose the class.

Weigh the mailpiece and measure the dimensions

1. Tap **Print on Envelopes** on the Home screen.
2. If you have the accounting feature enabled, tap **Account** and select an account.
3. Place the mailpiece on the scale. The weight appears. You can also weigh the mailpiece using any other postal scale.

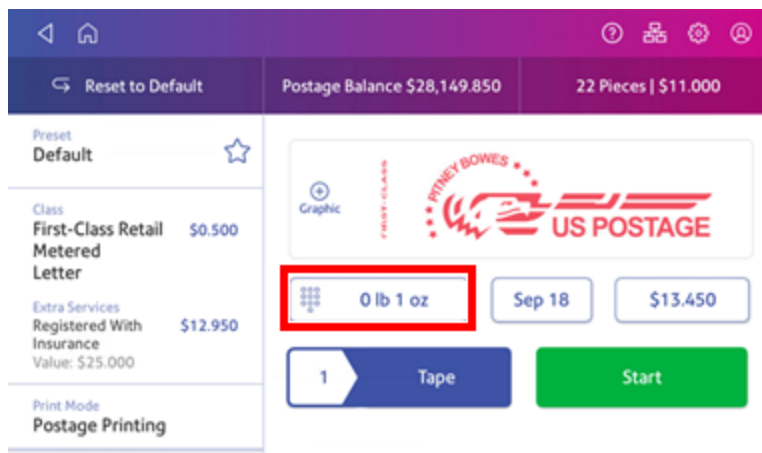

4. Measure and record the dimensions of the mailpiece.
5. Tap **Home** to return to the Home screen.

If the mailpiece is less than 3.5 oz, but has the dimensions of a large envelope:

1. Tap **Home**.
2. Tap **Print on Envelopes**.
3. If you have the accounting feature enabled, tap **Account** and select an account.
4. Tap **Class**.
5. Tap **Start Over** to show a list of all the available classes.
6. Tap **First-Class Retail Metered** for a First-Class mail envelope.
7. Tap **Large Envelope**.
8. Select special services, if required.
9. Tap **Apply**.
10. Place the envelope or envelopes on the feed deck. Depending on the SendPro C model you have, feed the envelopes manually or tap **Start** to feed the envelopes.
If the envelope is too thick to go through the feeder, print the postage on a tape and apply the tape to the large envelope or flat.

Sending Certified Mail

Certified Mail is a USPS service that provides you with proof of mailing by sending you a receipt once your mailpiece arrives at its destination.

Not all extra services like Certified Mail are available for all classes and you can only combine certain services.

1. Tap **Print on Envelopes** on the Home screen.
2. If you have the accounting feature enabled, tap **Account** and select an account.
3. Tap **Class**.
4. Tap **Start Over** to show a list of the available classes.
5. Tap a class that you can combine with Certified Mail (for example, First Class or Priority Mail).
6. Tap the mailpiece type (for example, letter or large envelope).
7. Select **Certified** and tap **Apply**.

8. Depending on the type class and type of mailpiece, enter the destination ZIP Code and tap **Apply**.
9. Place the envelope or envelopes on the feed deck. Depending on the SendPro C model you have, feed the envelopes manually or tap **Start** to feed the envelopes.
10. Place the green Certified Mail label (USPS Label 3800) on the mailpiece.

Sending an international letter

Use this process if you need to send mail from the United States to a different country.

1. Tap **Print on Envelopes** on the Home screen.
2. If you have the accounting feature enabled, tap **Account** and select an account.
3. Tap **Class**.
4. Tap **Start Over** to display a list of all the available classes.
5. Tap **First-Class Mail Intl Retail** for a First-Class Mail envelope.
6. Tap **Letter**.
7. Tap in the **Country** field and use the keypad to enter the destination country.
8. Select special services, if required.
9. Tap **Apply**.
10. Place the envelope on the scale. The weight appears.
11. Place the envelope or envelopes on the feed deck. Depending on the SendPro C model you have, feed the envelopes manually or tap **Start** to feed the envelopes.

Important: Your device will upload transactions if you have previously printed any mail. Once the upload completes, you see the message "Transaction upload status, Upload success" with a check mark. Tap the check mark.

Sending mail using a Certificate of Mailing

Purchase a Certificate of Mailing when you need to have proof that you sent a letter or package.

You can only obtain a Certificate of Mailing from the USPS. A Certificate of Mailing is a receipt that provides evidence of the date that you took your mail to the USPS for mailing. You cannot produce this certificate with your device. It is a record of when you turned the mailpiece over to the Post Office and you can only get it from the USPS.

1. Fill out the USPS postal forms [3606-D](#), [3665](#), or [3817](#). Obtain these at the Post Office or online at the [USPS website](#).
2. Calculate the fees for all of the mailpieces. This can include the cost of the Certificate of Mailing fees as well as the total postage amount.
3. Tap **Print on Envelopes** on the Home screen.
4. If you have the accounting feature enabled, tap **Account** and select an account. If your device's model number is 8H00 or 9H00 and if you have only a single account, once you select that account the device will remember that account the next time you start Print on Envelopes.
5. Scroll down and tap **Print Mode** on the Print on Envelopes screen.
6. Tap **Certificate of Mailing**.

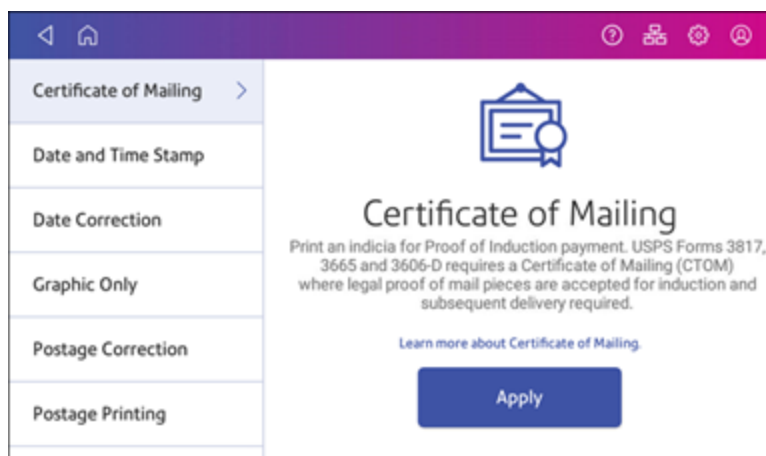

7. Tap **Apply**.

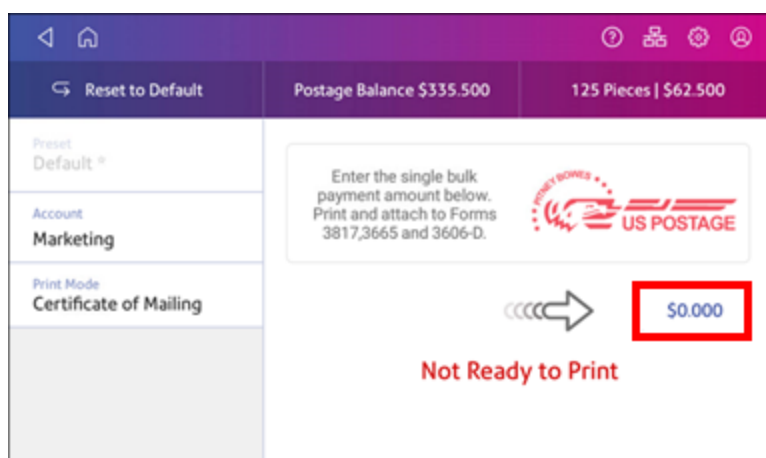

8. Tap on the postage amount and enter the amount you calculated in step 2.

9. Feed the appropriate form (3606-D, 3665, or 3817) through the feeder so that the device stamp prints on the form or on a tape strip that can be applied to the form. Alternatively, you can print the device stamp on each of the mailpieces included in the Certificate of Mailing.
10. Take the mailpieces and the printed form to the Post Office. They will apply a round stamp proof of induction mark that serves as legal proof that your items will enter the USPS.

Using USPS special services

You can select additional services for your mail. These include Certified Mail, Insured Mail, Delivery Confirmation, Registered Mail and more. The number and types of services available depend on the class of mail.

1. Tap **Print on Envelopes** on the Home screen.
2. Tap **Class**.
3. Tap **Start Over** to see a list of the available classes.
4. Tap the class you wish to use. Sub-classes appear when available for the selected class.
 - For some classes, you must select the type of mailpiece. For example, if you select First-Class Retail Metered, you must select either Letter, Large Envelope, or Package.
5. Select any special services you wish to use.
6. Enter a ZIP code if required.
7. For some classes, you need to either scan or manually enter the Electronic Certified barcode from your label. Then, attach your label to your envelope or package.
8. Tap **Apply**.

Updating postal rates or software for printing on envelopes

Automatic updates

Your device updates postal rates and software automatically.

Keep your device turned on and connected to your network to get your automatic updates, as the device downloads updates during the evening hours.

Manual postal rate updates

1. Select Rates and Updates:
 - Tap **SendPro Apps**, then **Rates and Updates**.
2. If new rates are available, your device downloads and installs updates.
 - a. If the rates are available today, this message appears:
"New postage rates took effect today. Your device has been updated and new rates are already in effect. To learn more, visit pitneybowes.com/ratesandupdates."
 - b. If the rates took effect already, this message appears:
"New postage rates took effect on [effective date]. Your device has been updated and new rates are already in effect. To learn more, visit pitneybowes.com/ratesandupdates."
 - c. If the new rates are pending, this message appears:
"New postage rates take effect on [future effective date]. Your device has been updated and you'll see the new rates then. To learn more, visit pitneybowes.com/ratesandupdates."
3. To continue tap **Got it**.

Manual software updates

1. Select Rates and Updates:
 - Tap **SendPro Apps**, then **Rates and Updates**.
2. If new rates are available, your device downloads and installs updates.
 - a. If the rates are available today, this message appears:
"New postage rates took effect today. Your device has been updated and new rates are already in effect. To learn more, visit pitneybowes.com/ratesandupdates."
 - b. If the rates took effect already, this message appears:
"New postage rates took effect on [effective date]. Your device has been updated and new rates are already in effect. To learn more, visit pitneybowes.com/ratesandupdates."
 - c. If the new rates are pending, this message appears:
"New postage rates take effect on [future effective date]. Your device has been updated and you'll see the new rates then. To learn more, visit pitneybowes.com/ratesandupdates."
3. To continue tap **Got it**.

Adding or refilling postage for printing on envelopes

Add or refill postage for your Print on Envelopes balance as soon as you receive a message that your funds are getting low.

Before you begin

Check that your device is connecting to the internet.

- For wired network connections, the following connection image appears in the toolbar:



- If you have a wireless connection, the following connection image appears in the toolbar:



Add postage for Printing on Envelopes

1. Tap **Print on Envelopes** on the Home screen.
2. Tap **Postage Balance**.
3. Tap **Refill Postage**.
4. Enter the amount of postage you wish to add.
5. Tap **Refill Mail Postage**.
6. Tap **View Receipt** to view or print a receipt.
7. Tap **Done**.
8. Your updated postage balance appears on the Print on Envelopes app.

Sealing envelopes when you print postage

You can seal envelopes and print postage at the same time with your SendPro C Lite, SendPro C, SendPro+.

1. Check the level of sealing solution in the moistener tank. Add more if required.
2. Slide the envelope flap under the edge of the feed deck so the moistener can wet the flap.



3. Tap **Print on Envelopes** on the Home screen.
4. Tap **Account** and select an account if accounting is enabled on your device.

5. Tap **Weight**.

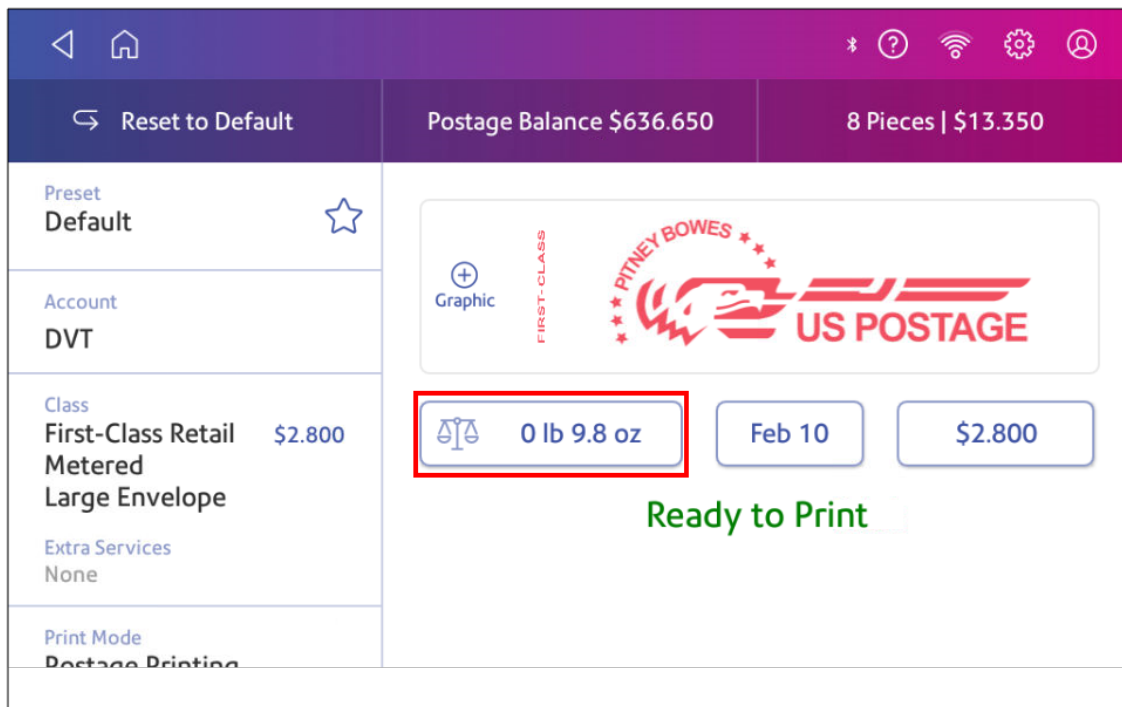

6. Tap **Scale**.

7. Place the envelope on the scale. You must do this before the next step or else **Apply** remains inactive.

8. Tap **Class** then select the class of mail you want.

9. Tap **Graphic** then select a graphic, if necessary.

10. Tap **Apply** to continue.

11. Insert the envelope into the device. The device prints the postage .

Important: If the moistener tank is full and your envelopes do not seal correctly, clean or replace the moistener brush and wick.

Filling the moistener tank

Your device will need refills of E-Z Seal® in order to seal envelopes. Follow these steps to fill the moistener tank.

1. Check the level of E-Z Seal® in your moistener tank (1).

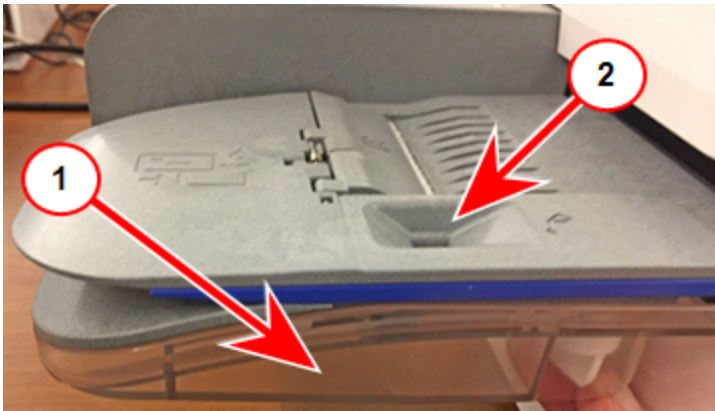

2. Add enough E-Z Seal® to bring the sealant level up to the bottom of the fill hole (2). Do not overfill the tank.
3. If the tank is empty, allow 30 minutes for the moistener brush and wick to get completely wet.

Replacing the ink cartridge

Replace the ink cartridge when the low ink warning appears. This ensures your device is in optimal working condition.

1. Tap **Settings**.



2. Scroll down and tap **Mail Printer Maintenance**.
3. Tap **Install Ink**.
4. Lift the top cover. The ink cartridge moves to the front position.

5. Remove the ink cartridge, as shown on the label next to the cartridge holder.

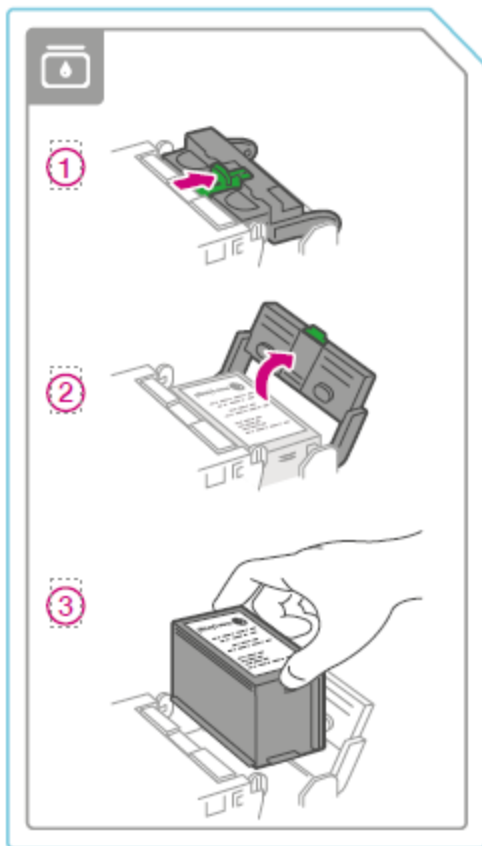

6. Insert the new ink cartridge, then close the ink cartridge guard.

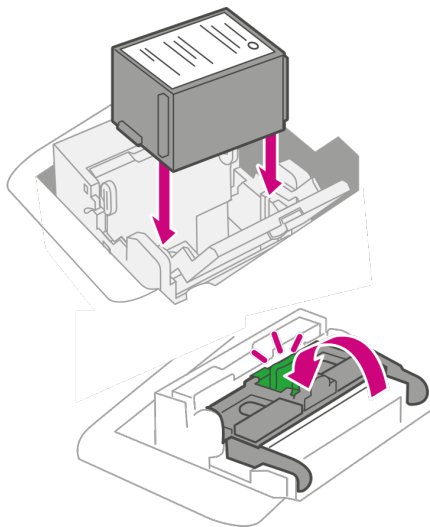

7. Close the top cover.

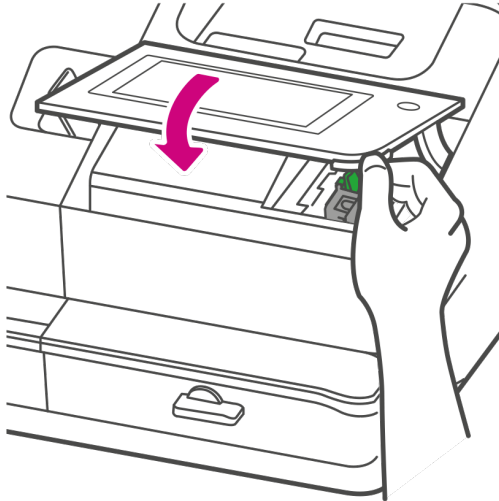

8. The cartridge repositions itself and the Mail Printer Maintenance screen appears.
9. Print a test pattern to ensure that your ink cartridge installs properly.

Printing a test pattern

Print a test pattern to see if the printhead is working properly or if you have enough ink in the cartridge.

1. Tap **Settings**.



2. Scroll down and tap **Mail Printer Maintenance**.
3. Tap **Print Test Pattern**.
4. Insert the envelope into the device when the message "Print a Test Pattern?" appears.

5. Examine the pattern printed on the envelope:
 - Tap **Done** if the lines are unbroken and match the "Good" test pattern shown on the display.
 - Tap **Clean Print Nozzle** if the test pattern has missing or incomplete lines
 - Once the cleaning operation completes, you must print another test pattern.
 - If this new pattern still has broken or missing lines, you may need to replace the ink cartridge or clean or replace the printhead.
 - If you see no improvement in print quality, do not repeat the cleaning, as cleaning the print nozzles consumes ink.

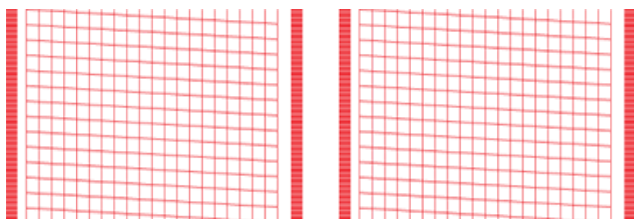

Good Test Pattern

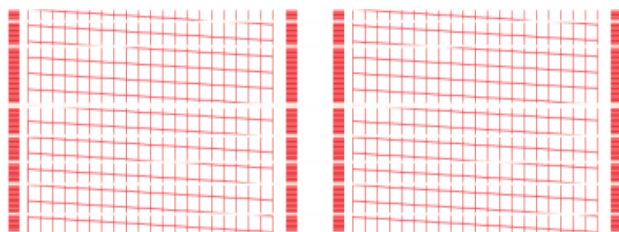

Bad Test Pattern

Adding favorite apps

Add your favorite apps to make them easy to find on the Home screen.

1. Tap **SendPro Apps** on the Home screen. All the available apps display.
2. Tap **Edit favorites** and a star appears next to each app.

3. Tap the star next to an app to make it a favorite.

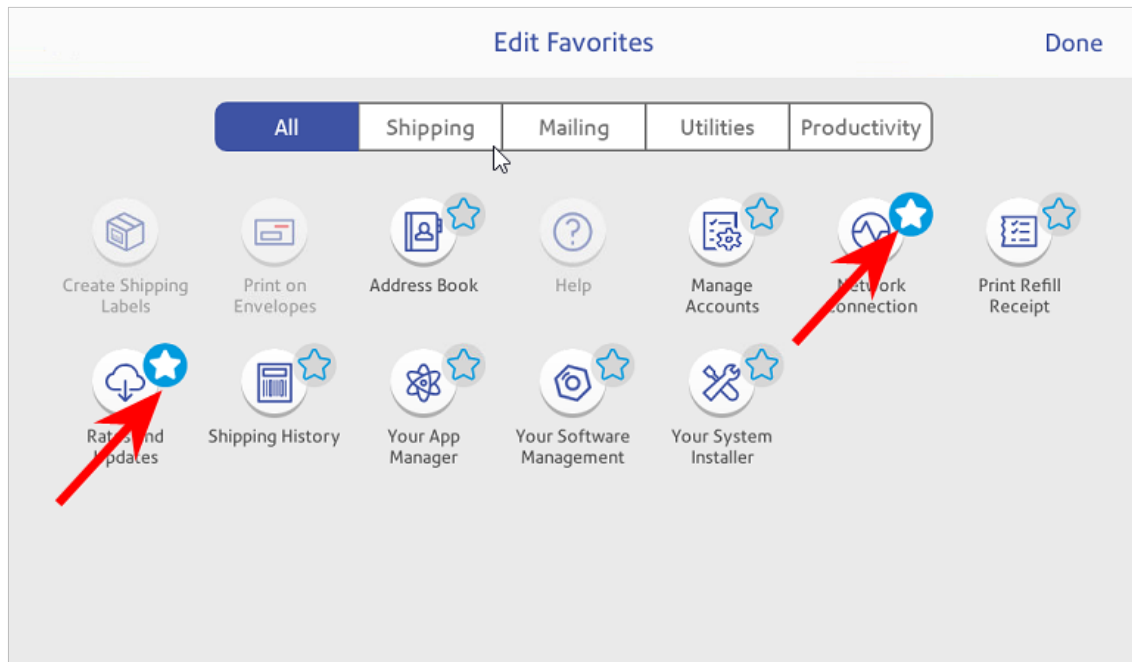

4. Tap **Done** when complete.

Creating presets for printing postage

Create presets to store a group of commonly-used settings. Presets can store settings such as a postage class, an account and a graphic. The maximum number of presets you can have is 21. This includes the default preset.

1. Tap **Print on Envelopes** on the Home screen.
2. Tap **Class**, select the class and any special services, messages or graphics.
3. Verify the settings in the Print on Envelopes app.

4. Tap the **star** in the Preset box.

Important: You must modify something in the Print on Envelopes app for the Preset star to appear.

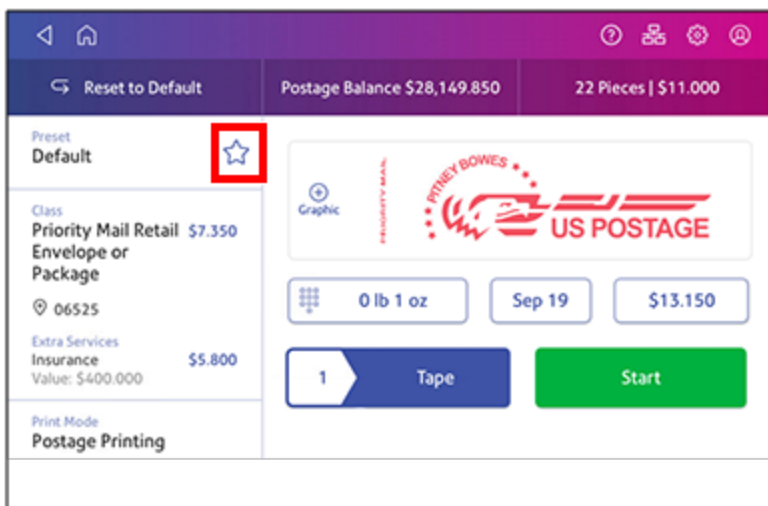

5. Tap **Save New Preset** to save it. If you wish to save it and replace the default setting, tap **Replace Default Preset**.

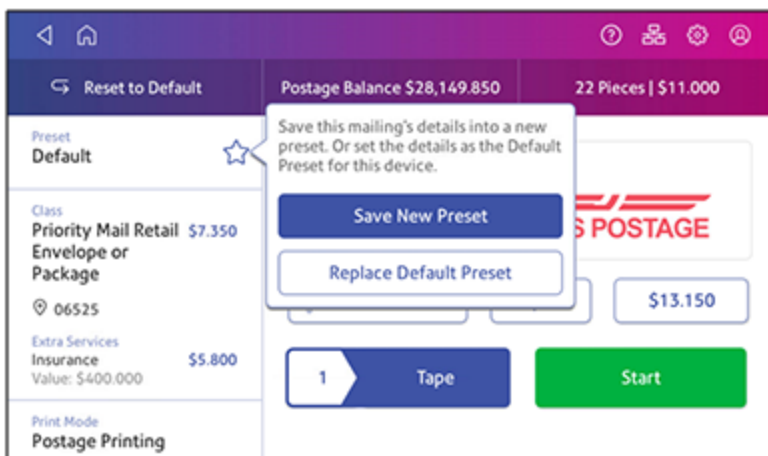

6. For a new preset, enter a name, then tap **Save**.

Selecting a preset for printing postage

Select a preset to quickly apply a group of settings.

1. Tap **Print on Envelopes** on the Home screen.
2. Tap **Preset**.
3. Tap the preset you want to use, then tap **Apply Preset**.

If you select a preset and do not use it within about one minute, the Print on Envelopes screen restores the default preset values. The same is true when you switch your device off or it enters sleep mode.

2 - Connectivity information

In this section

Setting up a wired network connection.....	42
Setting up a wireless (Wi-Fi) network connection.....	45
Connecting to a hidden Wi-Fi network.....	45
Forgetting a Wi-Fi network.....	47
Checking your network connection.....	49
Finding the MAC address for wired and wireless networks.....	49
Setting up a Proxy server.....	53

Setting up a wired network connection

Use a network cable to connect your device to the Pitney Bowes Data Center.

Step 1: Plug in your network cable

Plug one end of your network cable to your device and the other end to an internet jack on the wall or a router.

Step 2: Choose the connection type

Select one of the two connection types supported for this device:

- *DHCP*
- *Static IP*

DHCP is the most common connection type. Choose DHCP if you are unsure which connection protocol to use or contact your IT department for advice.

DHCP

1. Tap **Settings**.



2. Tap **Wired**.

3. Select **DHCP**.

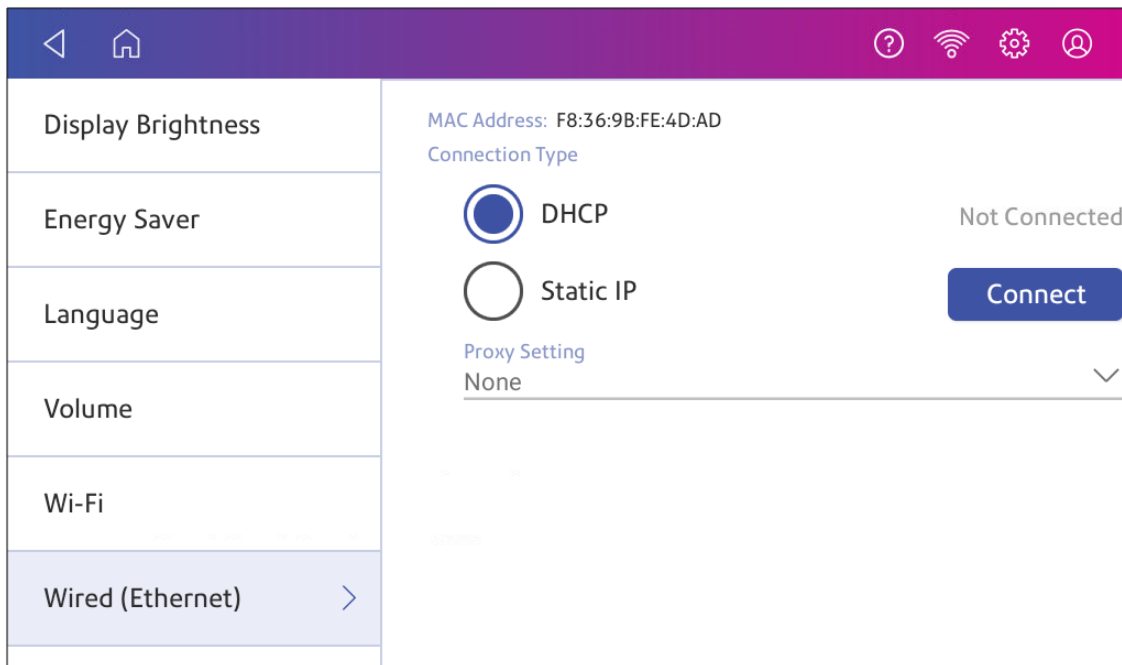

4. Tap **Connect**.
5. If it does not connect, unplug the power cord.
6. Wait 30 seconds. The screen should turn off after 10 seconds.
7. Plug the power cord back in directly into a wall outlet.
8. Quickly tap and release the power button to turn the device back on.
9. Tap **Settings**.



10. Tap **Wired (Ethernet)**.
11. Tap **DHCP**.
12. Tap **Connect**.

Static IP

1. Tap **Settings**.



2. Tap **Wired**.
3. Select **Static**.

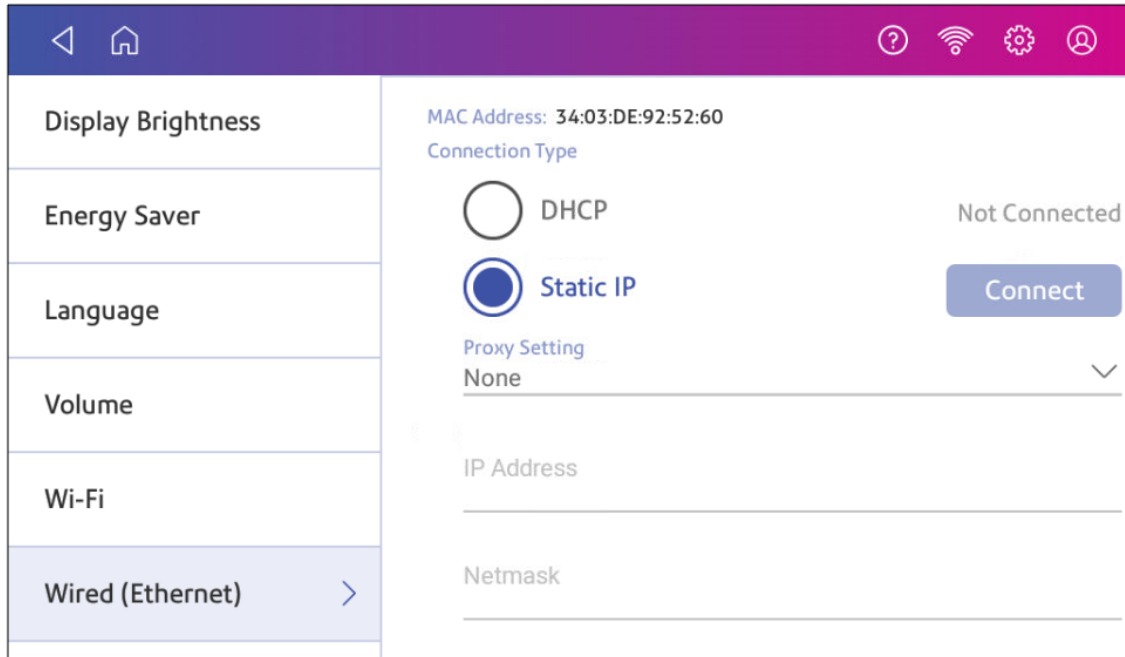

4. Contact your IT department to obtain the settings you will need to enter for your device. The values needed are:
 - **IP Address**
 - **Netmask**
 - **Gateway**
 - **DNS Address.**
5. Enter the settings you obtained in step 4 for the **IP Address**, **Netmask**, **Gateway**, and **DNS Address** in the corresponding fields.
6. Tap **Connect**.
7. If the device fails to connect, remove the network cable from the back of the device.
8. Tap **Connect**. Wait for the attempted connection to fail.
9. Plug the network cable back in.
10. Delete the values in the **IP Address**, **Netmask**, **Gateway**, and **DNS Address** fields.
11. Enter the **IP Address**, **Netmask**, **Gateway**, and **DNS Address** that you obtained in step 4.
12. Tap **Connect**.

NOTE: If your device's model number is 8H00 or 9H00 it will remember the Static IP information even if you switch back to DHCP and then back again. This information includes IP Address, Netmask, Gateway and DNS Address as well as the proxy information.

Setting up a wireless (Wi-Fi) network connection

You can connect your device with a wireless network connection.

1. Tap **Settings**.



2. Tap **Wi-Fi** in the Device & Network section.
3. Choose your Wi-Fi network from the list. Tap **Add Network** if your Wi-Fi network does not appear.
4. Enter your Wi-Fi password.
Tip: Use the show password option to make sure that you enter your password correctly.
5. Tap **Advanced Options** if your network requires advanced network settings such as a Static IP address:
 - To set up a Static IP address:
 - a. Select the **IP Setting** menu and choose **Static**.
 - b. Tap on the line and enter the value provided by your IT department.
 - c. Tap the > in the green circle.

Connecting to a hidden Wi-Fi network

Add a network when you want to connect using Wi-Fi and your network is not present in the Wi-Fi list.

1. Tap **Settings**.



2. Tap **Wi-Fi** in the Device & Network section to see a list of available networks.

3. Tap **Add Network** at the top of the Wi-Fi screen.

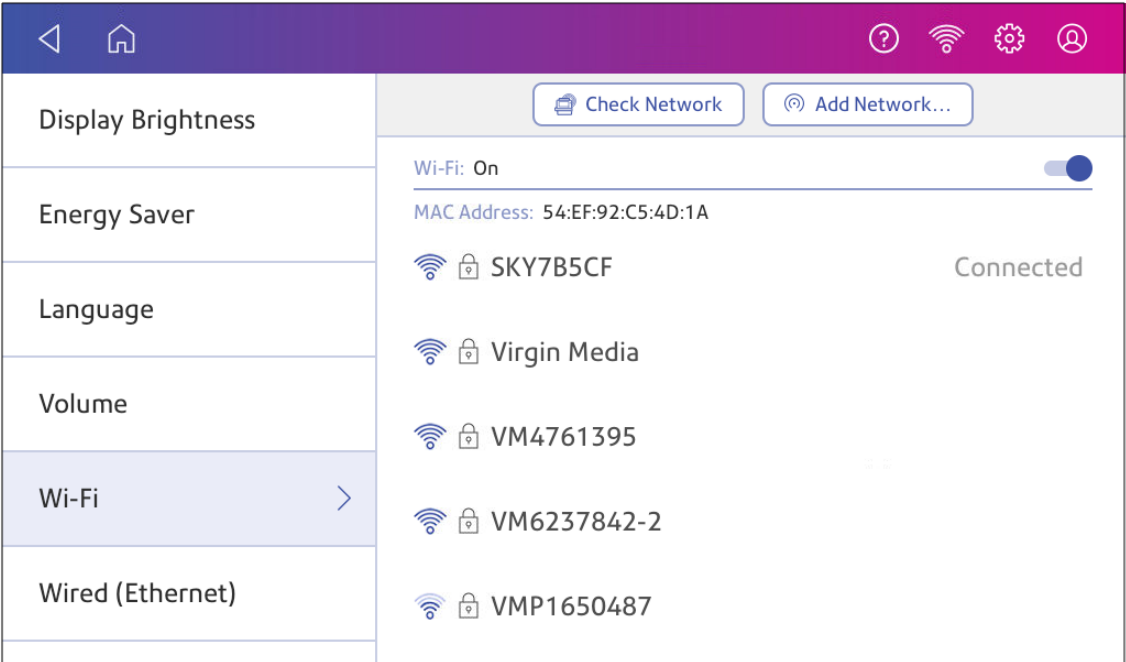

4. For each of the following steps, please consult with your IT department to obtain the necessary information.
 - a. Tap the down arrow in the Security field and select the security method.

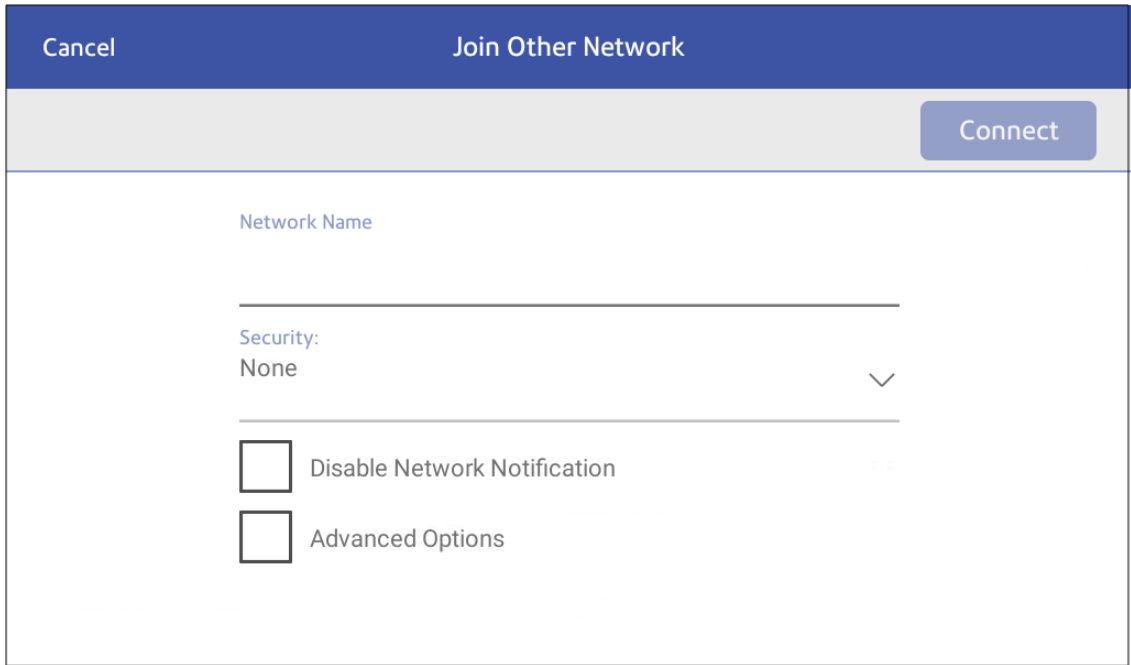

- b. Tap **Advanced Options** to enter a static IP or set up a proxy.
5. Tap **Connect** when done.

Forgetting a Wi-Fi network

Forget a Wi-Fi network if:

- You do not want your device to automatically connect to that network or
- You need to resolve a wireless network issue.

1. Tap **Settings**.



2. Tap **Wi-Fi** in the Device & Network section.

3. Tap the network you want to forget. Note that you can only forget a network to which you have previously connected.

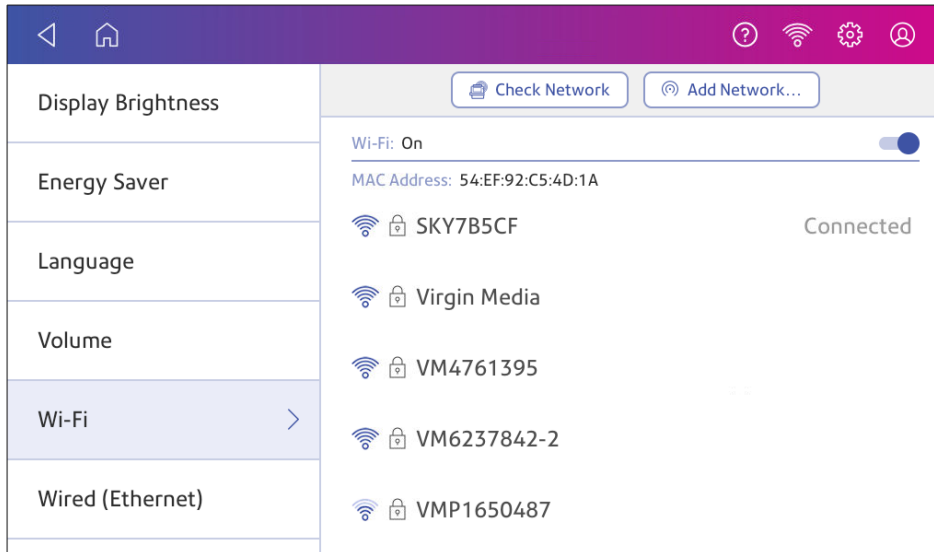

The network details appear.

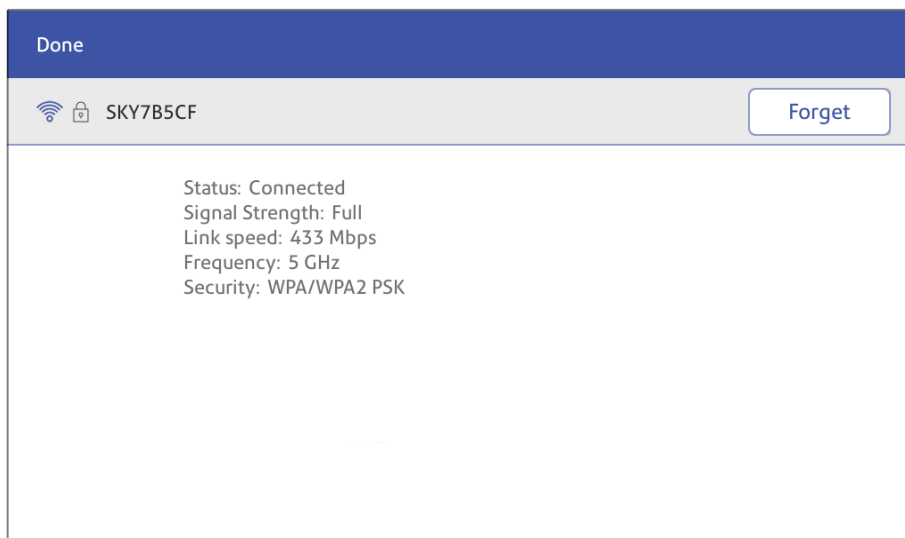

4. Tap **Forget** to forget the network connection.

Checking your network connection

Use the Network Connection app to check that you have the necessary internet services to connect to the internet. The app helps diagnose network connection issues.

Your IT department may be blocking certain services. Only they will know if the necessary services are available on your network.

1. To open and run the network checking app:
 - Tap **SendPro Apps** on the Home screen, then tap **Network Connection**.
2. The device then provides you with the results of the network check.
3. Tap **Close** twice to return to the Home screen.

If you are unable to connect to the internet, ask your IT department or internet provider to check the internet settings before you contact Pitney Bowes.

Finding the MAC address for wired and wireless networks

The MAC address is the network identifier for the device. IT uses it to allow the device onto the network.

Your device contains two MAC addresses: One for wireless connections and one for wired connections.

Locating the MAC address for wireless connections

1. Tap **Settings**.



2. Tap **Wi-Fi**.

3. The MAC address appears above the list of wireless networks.

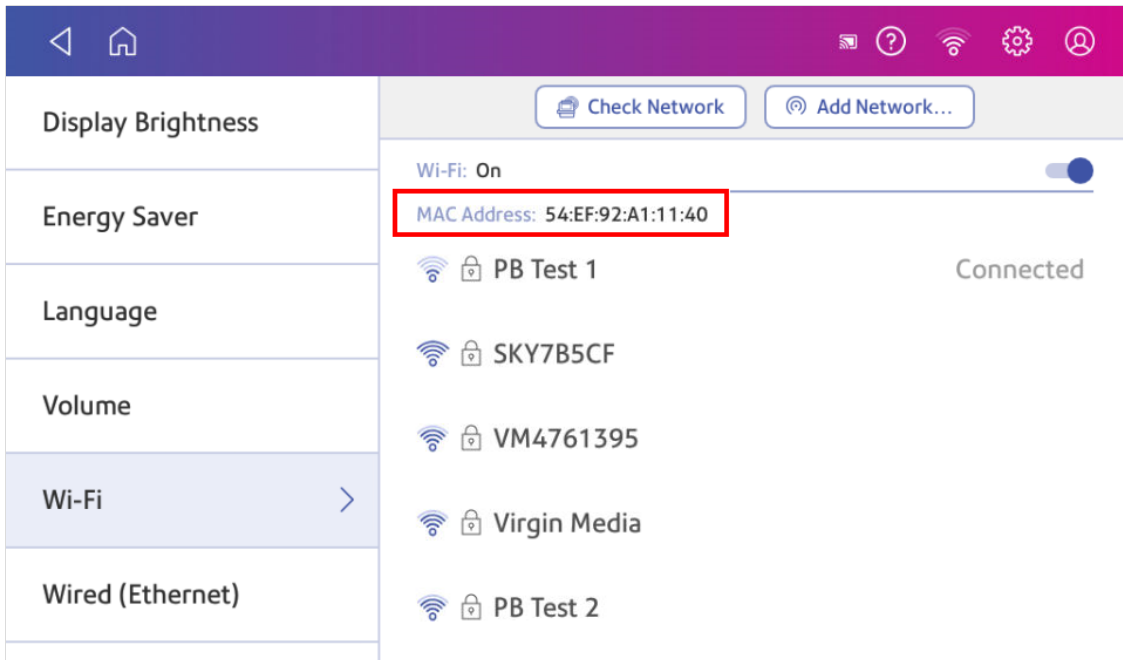

Locating the MAC address for wired connections

1. Tap **Settings**.



2. Tap **Wired (Ethernet)**. The MAC address is present at the top of the screen.

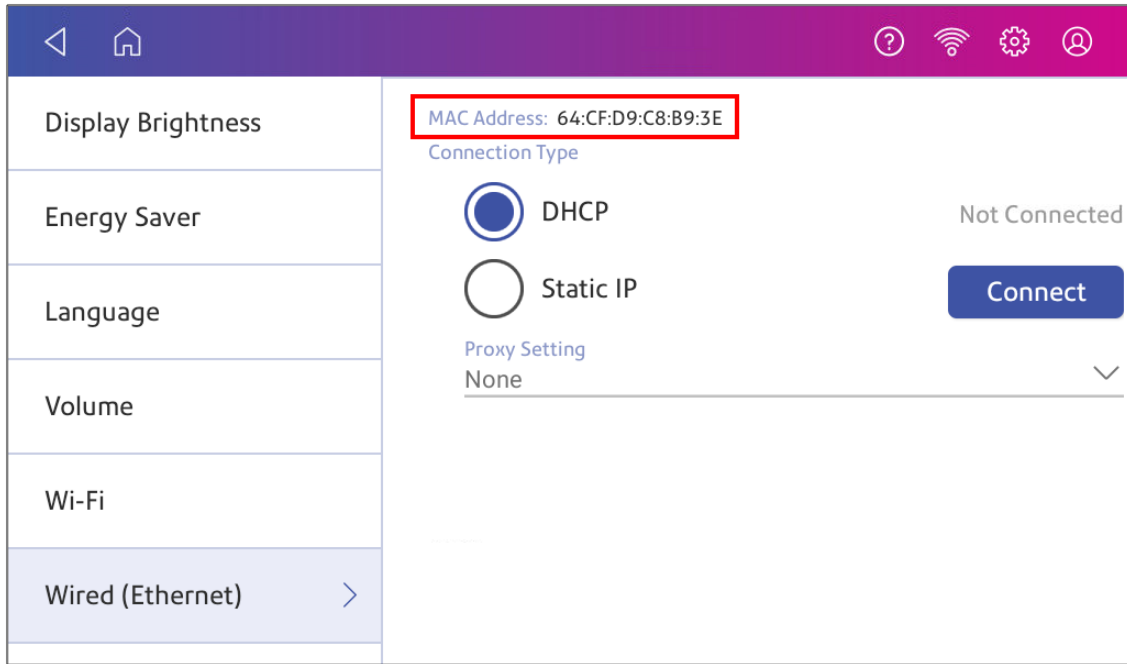

3. Tap **Check Network**. The Checking Network Connection screen appears.

4. Tap **View Details** in the Connected to wired network box when the test finishes.

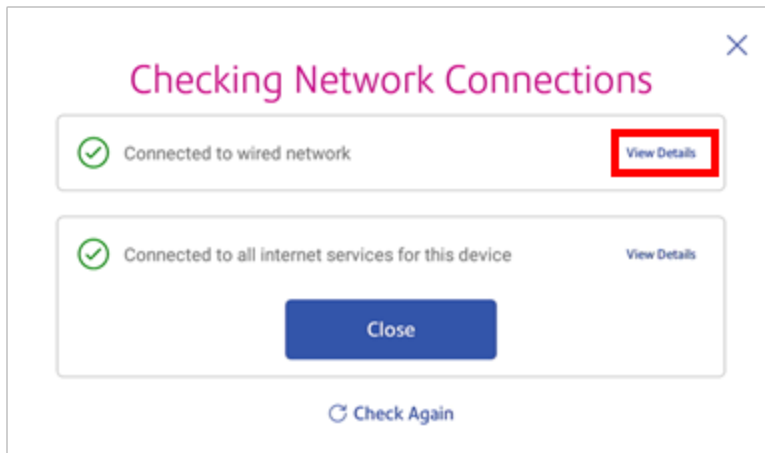

The MAC address appears:

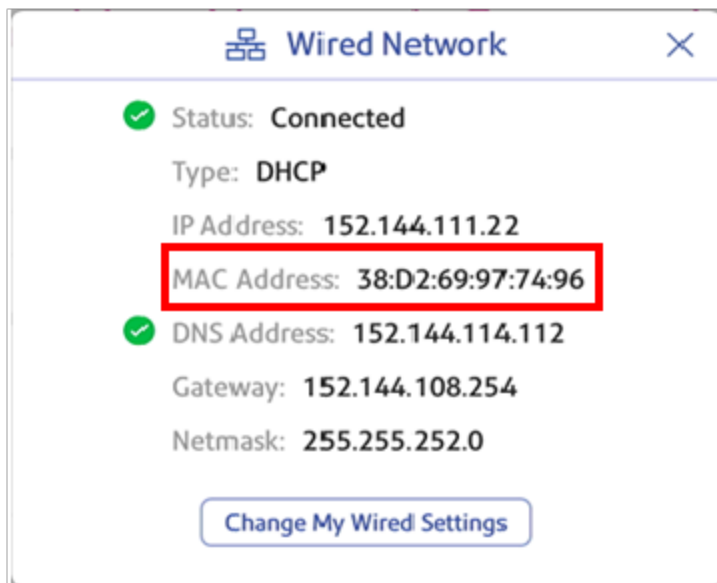

5. Tap **X** to close this window.
6. Tap **Close**, then the **back arrow** to return to the Home screen.

If the MAC address does not appear, try these steps:

1. Tap **Settings**.



2. Scroll down to the Advanced Device Options section and tap **About this C-Series**.
3. Scroll down to the Base Network Info section to locate the MAC Address.

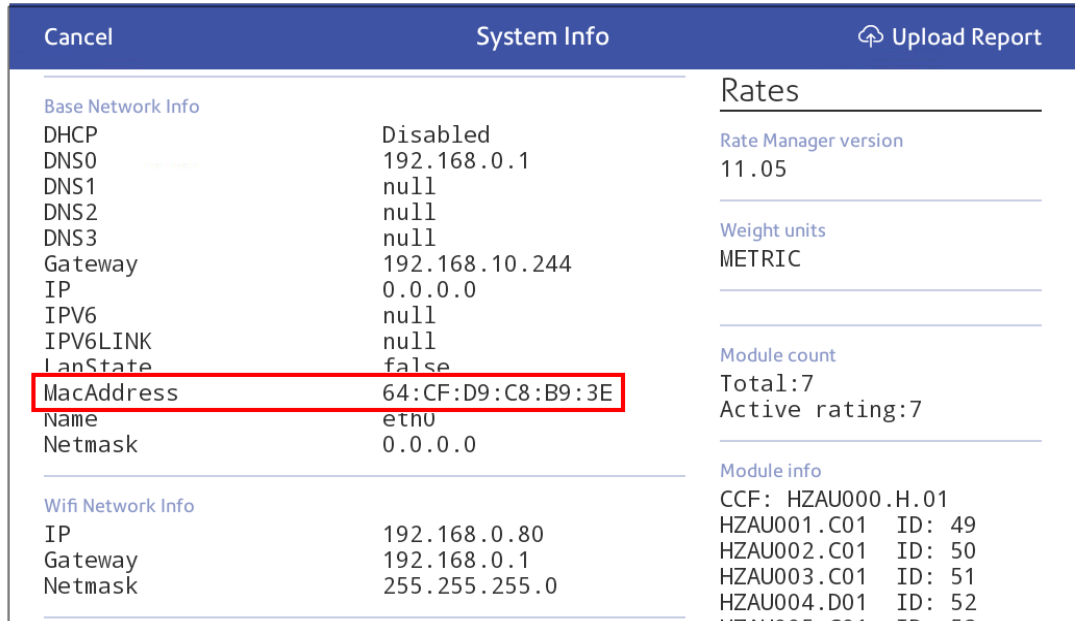

4. Tap **Cancel** to return to the Home screen.

Setting up a Proxy server

A Proxy server is a computer that acts as a gateway between your local network, your device, and the internet. Proxy servers provide increased performance and security.

If your network requires a proxy server, you must contact your IT department or service provider to obtain the proxy server information to set up a proxy server.

Choose the connection type

Choose how you connect your device to set up a Proxy server:

- [Setting up a Proxy server using a Wi-Fi network connection](#)
- [Setting up a Proxy server using a wired network connection](#)

Setting up a Proxy server using a Wi-Fi network connection

1. Tap **Settings**.



2. Tap **Wi-Fi** in the Device & Network section.
3. Select the network from the list.
4. Tap on the **Advanced Options** checkbox to select it.
5. Scroll down and tap the arrow next to Proxy, then select **Manual**.

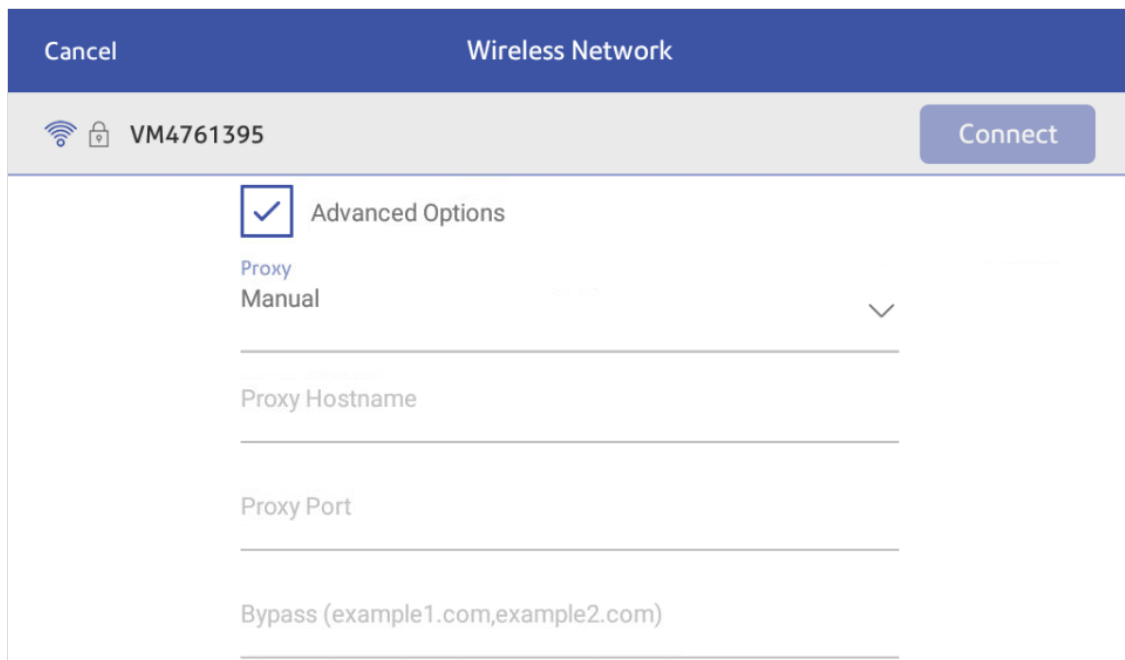

6. Enter the IP address, HTTP or HTTPS proxy address of your proxy server in the **Proxy Hostname** field.
7. Enter the port number for the proxy server in the **Proxy Port** field.
8. (Optional) Enter any specific URLs or URL patterns (such as internal addresses) that you wish to bypass the proxy in the **Bypass** field.

9. If your Proxy Server requires authentication, select the **Need Authentication** check box. Additional fields appear.
 - a. Enter the Proxy username in the **Proxy Username** field. This may be case sensitive for some proxy servers.
 - b. Enter the Proxy password in the **Proxy Password** field. This is case sensitive for proxy servers.

Setting up a Proxy server using a wired network connection

1. Tap **Settings**.



2. Tap **Wired (Ethernet)** in the Device & Network section.
3. Select either **DHCP** or **Static IP**.
4. If you select DHCP, tap on the drop-down arrow next to Proxy Setting and select **Manual**.

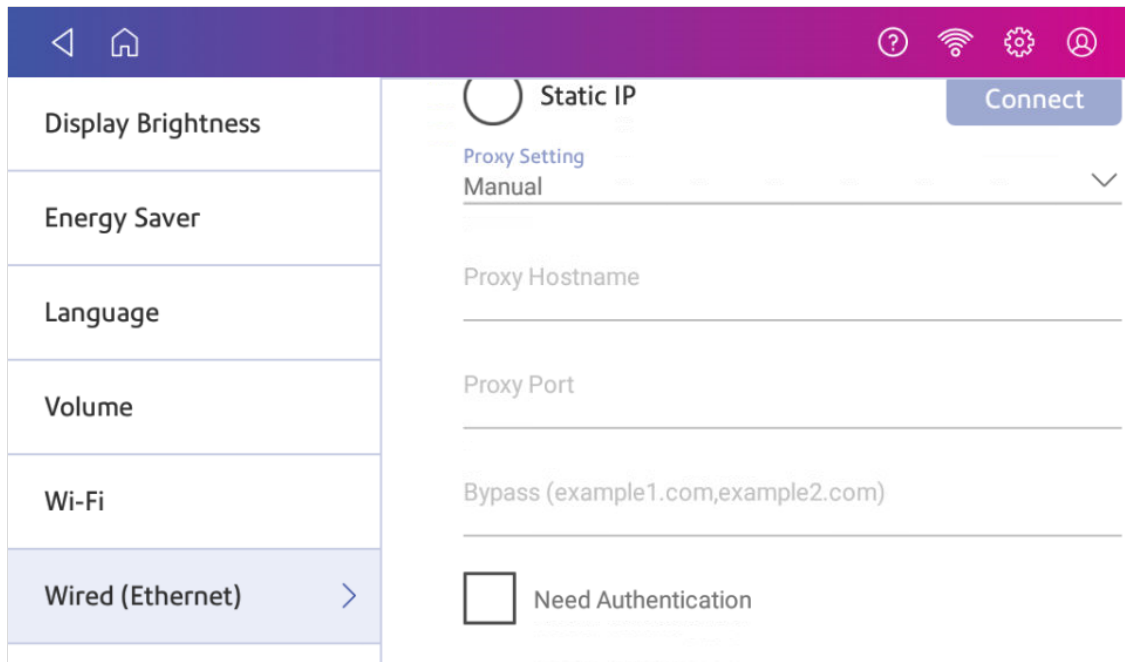

5. Enter the IP address, HTTP or HTTPS proxy address of your proxy server in the **Proxy Hostname** field.
6. Enter the port number for the proxy server in the **Proxy Port** field.

7. (Optional) Enter any specific URLs or URL patterns (such as internal addresses) that you wish to bypass the proxy in the **Bypass** field.
8. If your Proxy Server requires authentication, select the **Need Authentication** check box. Additional fields appear.
 - a. Enter the Proxy username in the **Proxy Username** field. This may be case sensitive for some proxy servers.
 - b. Enter the Proxy password in the **Proxy Password** field. This is case sensitive for proxy servers.

3 - Managing your Device

In this section

Creating or disabling the security PIN.....	58
Adjusting time zone and scale location code.....	59
Adjusting display brightness.....	59
Adding favorite apps.....	60
Setting up the Energy Saver.....	61
Using USPS Informed Delivery.....	61
Installing the SendPro C Lite, SendPro C, SendPro+....	61
Installing a scale.....	71
Uploading system logs.....	72

Creating or disabling the security PIN

Create a security PIN to prevent unauthorised use of your device.

If you created a security PIN when you installed your device, you must enter it when you turn your device on or after it enters sleep mode.

Create a security pin

1. Tap **Settings**.



2. Tap **Security PIN** in the Device & Network section.
3. Tap **Create PIN**.
4. Enter a 4-digit numeric PIN using the keyboard on the display.
5. Verify your PIN by entering it again.

Change or disable the security PIN

1. Tap **Settings**.



2. Tap **Security PIN** in the Device & Network section.
3. Tap **Change PIN** or **Turn OFF Security PIN**.
4. Enter the current security PIN for either option.

Manually lock your device

1. Tap the user profile image.

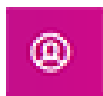

2. Tap **Lock this device**. The screen saver displays shortly after the Device is Locked screen appears.

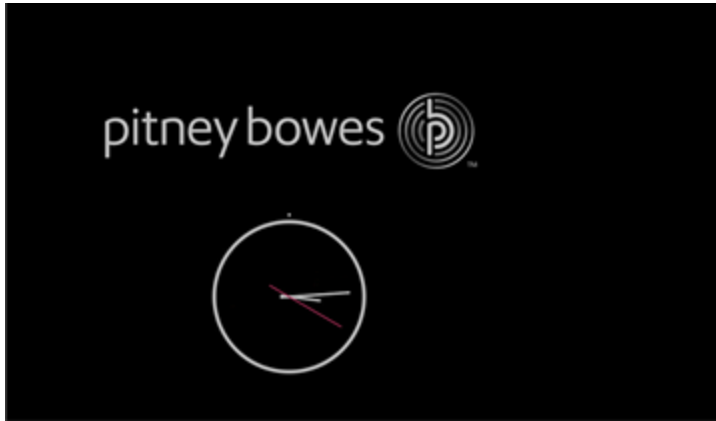

If you forget your Security PIN, tap on the **Forgot PIN?** link to get help.

Adjusting time zone and scale location code

When you move your device to a new location or install a new scale, you must modify the location code and time zone value.

1. Tap **Settings**.



2. Tap **Location & Time Zone**.
3. Enter the new location code.
4. Enter the time zone.
5. Tap **Apply**.

Adjusting display brightness

Set the brightness of the display to suit your work space.

1. Tap **Settings**.



2. Tap **Display Brightness** in the Device & Network section of the screen.
3. Move the slider to adjust the brightness.
4. Tap the **back arrow** or **Home** to exit the Settings screen.

Adding favorite apps

Add your favorite apps to make them easy to find on the Home screen.

1. Tap **SendPro Apps** on the Home screen. All the available apps display.
2. Tap **Edit favorites** and a star appears next to each app.
3. Tap the star next to an app to make it a favorite.

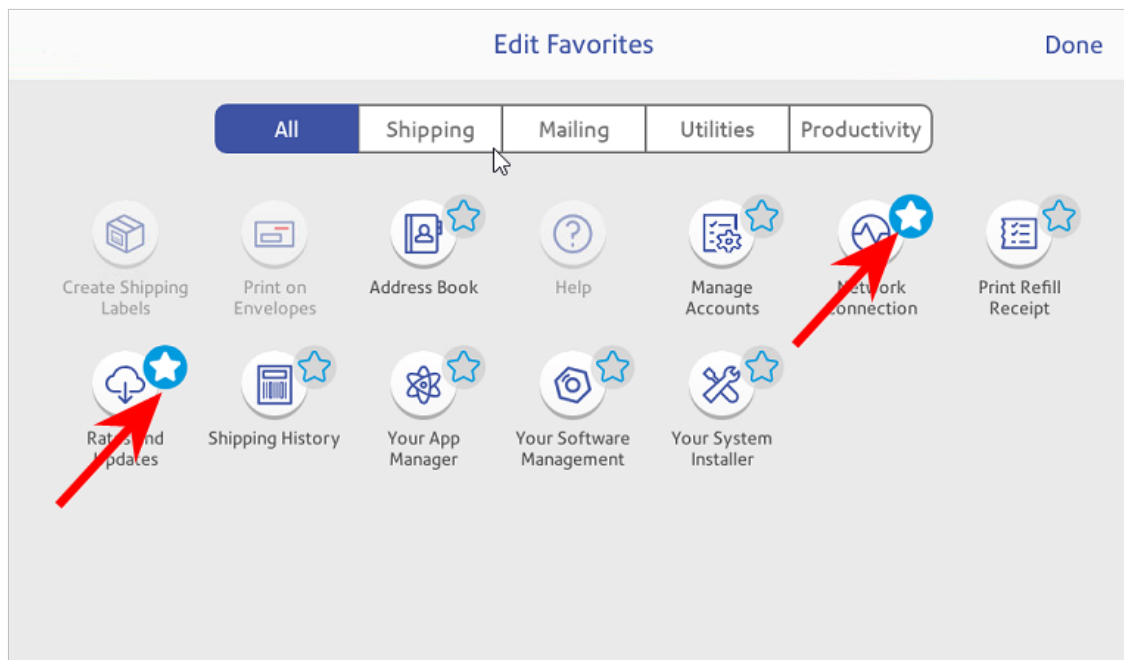

4. Tap **Done** when complete.

Setting up the Energy Saver

Use the energy saver to reduce energy usage. The energy saver turns your device off after a period of inactivity.

1. Tap **Settings**.



2. Tap **Energy Saver** in the Device & Network section.
3. Tap in the **Time after inactivity to turn off** field.
4. Select the amount of time you want your device to remain inactive before it shuts down. The shorter the time you select, the more energy you save.

Using USPS Informed Delivery

USPS Informed Delivery allows you to preview your mail and manage your packages. Informed Delivery allows you to:

- View grayscale images of the exterior, address side of letter-sized mailpieces.
- Track packages in one app.

For more information on USPS Informed Delivery, go to the USPS Informed Delivery website.

1. To access USPS Informed Delivery:
 - Tap **SendPro Apps** on the Home screen, then tap **USPS Informed Delivery**.
2. Enter your USPS.com username and password.
 - If this is the first time you are using Informed Delivery on your device, you need to verify your USPS account. Follow the prompts to complete the verification process.

Installing the SendPro C Lite, SendPro C, SendPro+

Follow these instructions to install a SendPro C Lite, SendPro C, SendPro+ for the very first time.

1. *Before you begin*
2. *Open the box*

3. [Unpack the device](#)
4. [Install the printhead](#)
5. [Install the ink cartridge](#)
6. [Connect device to a power source](#)
7. [Continue installation steps](#)

1 Before you begin



Before you begin the installation of your new SendPro C Lite, SendPro C, SendPro+:

- [Set up your postage payment method](#)
- [Choose your connection type](#)
- [Get account and password information](#)

Set up your postage payment method

Pitney Bowes offers different options to pay for postage for mailing and shipping. You must set up how you are going to pay for postage before you can use your device. For more information visit [paying for postage](#).

Choose your connection type

Wired Connections 	Take about 10 minutes to set up Require an ethernet port and power outlet.
Wireless Connections 	Take about 15 minutes to set up Require access to a wireless network and power outlet.

Get account and password information

To set up your device, you need:

- The email address and password that you use to sign into Your Account on Pitney Bowes.
- If you need to set up Your Account, use a browser on your computer to visit [Your Account](#) and click **Register Now**.

To print shipping labels you need:

- Your SendPro Online or PitneyShip email address and password for that account.
- If you have logged into Your Account on Pitney Bowes, or if you have used SendPro Online or PitneyShip to send a package, you can link to that account and use that email address and password.
- If you do not have a shipping label account, you have the option of creating one during the installation.

2 Open the box

In the box you will find:

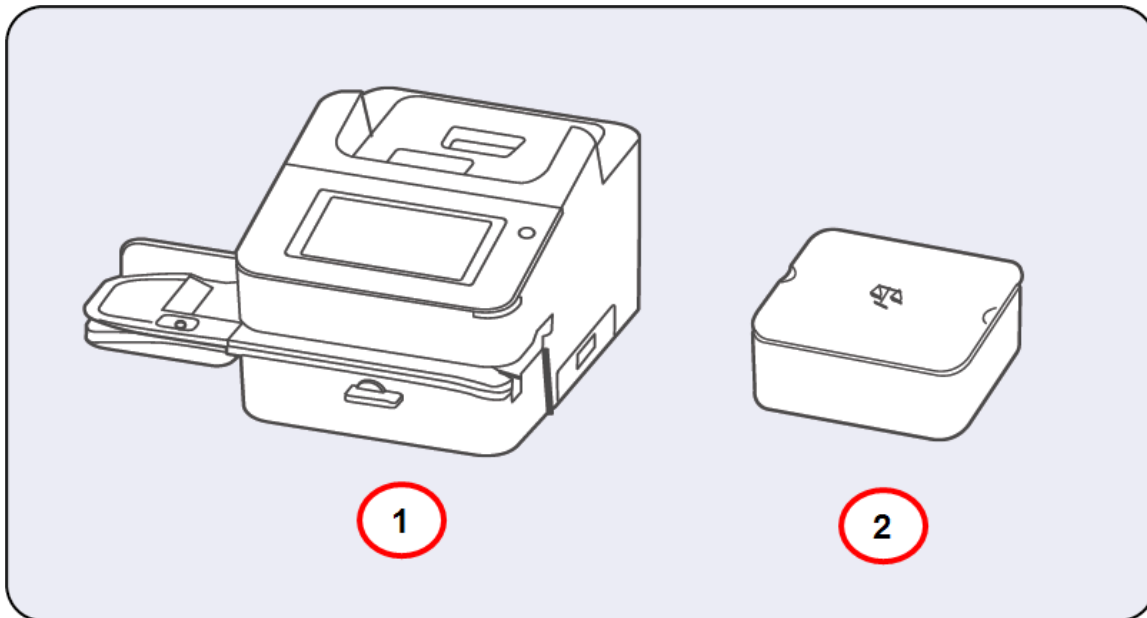

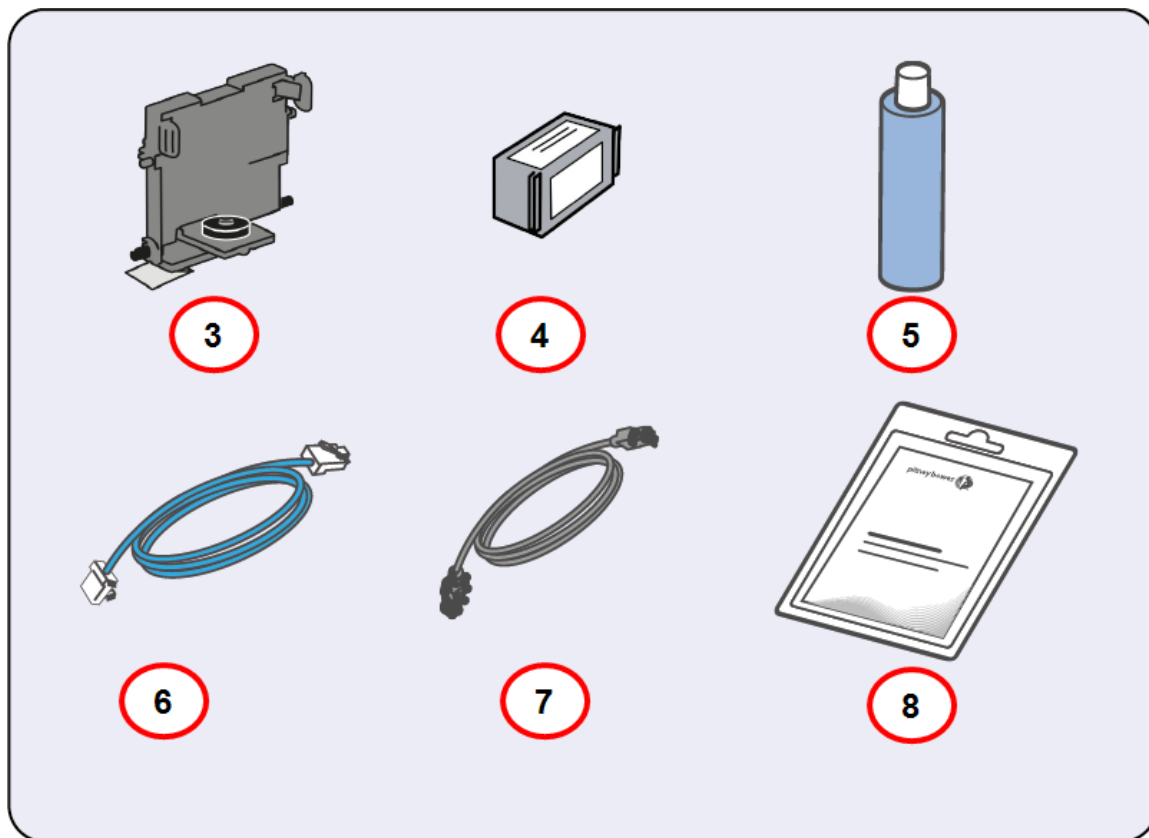

1. SendPro C, SendPro+.
2. Scale.
3. Printhead.
4. Ink Cartridge.
5. Sealing solution.
6. LAN / Internet Cable.
7. Power Cord.
8. Tape Sheets.

3 Unpack the device

1. Remove the device and all items from the box.



2. **Important:** Be sure to grab hold of the entire feeder, not just the moistener flap when lifting the device out of the box.



3. **Do not** connect your device to a power source yet.

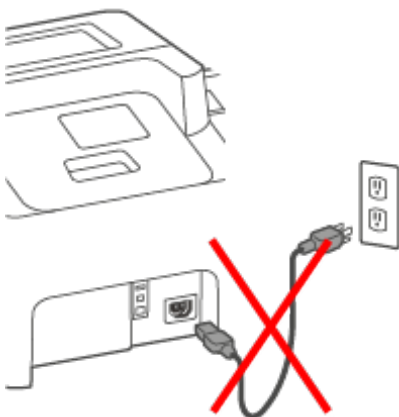

4. Remove all packing materials from the device.

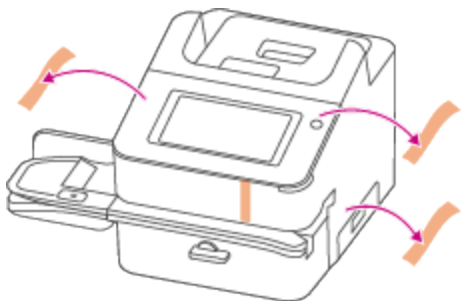

4 Install the printhead

1. Open the cover to access the ink carriage.

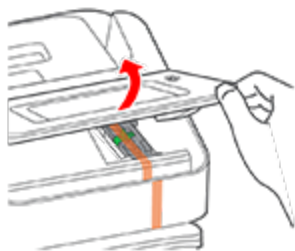

2. Remove the packing tape from the ink carriage.

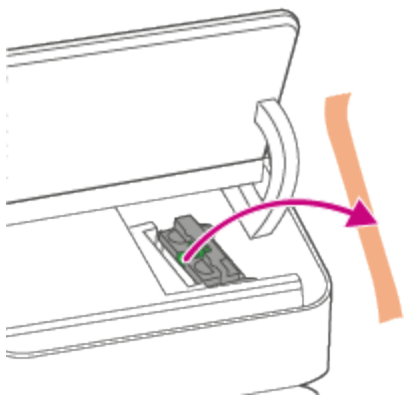

3. Open the ink carriage guard.

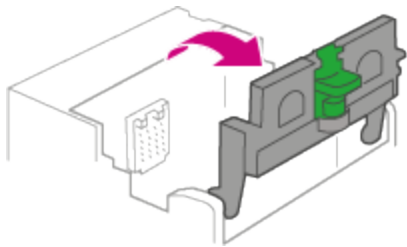

4. Unwrap the printhead and remove the protective strip.

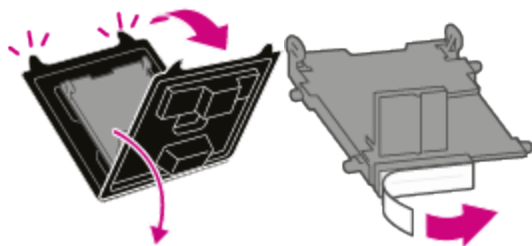

5. Squeeze the tabs and slide the printhead pegs into the lower set of grooves.
Important: This step is critical to prevent device damage.

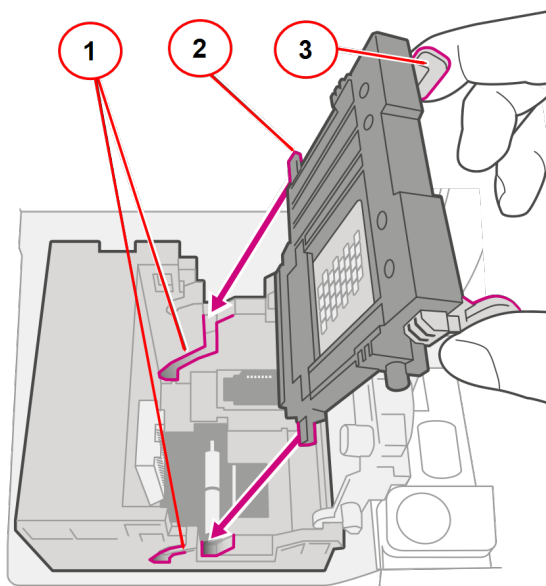

1. Grooves.
2. Peg.
3. Tab.

- Keep squeezing the tabs and push the printhead flush against the wall. The tabs snap outward when you place the printhead correctly.

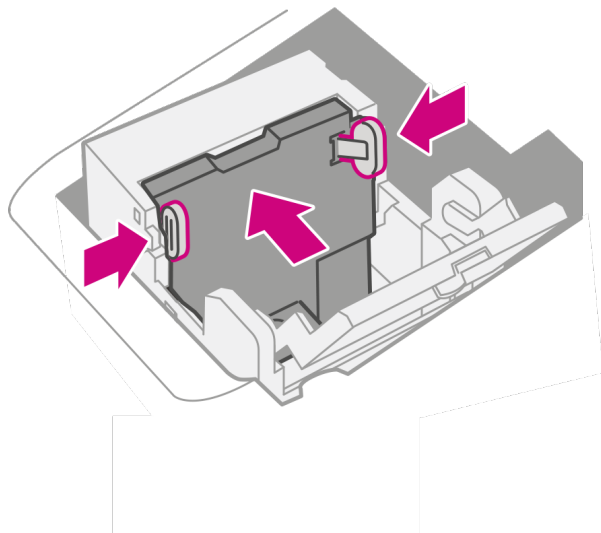

5 Install the ink cartridge

- Unwrap the ink cartridge and remove the silver foil strip from the ink cartridge.

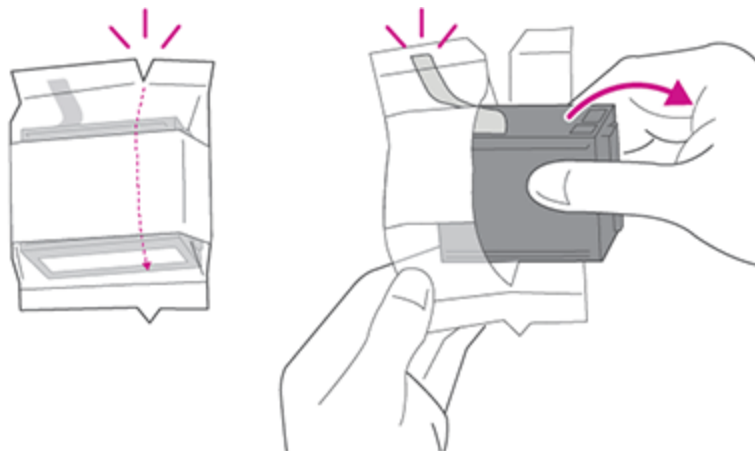

2. Install the ink cartridge and close the guard.

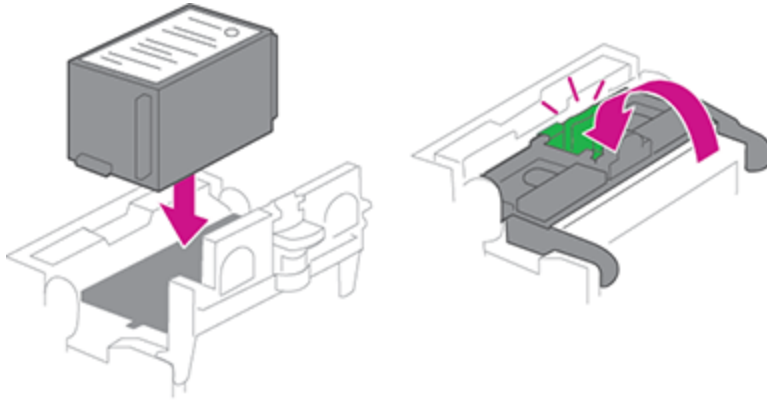

3. Close the cover.

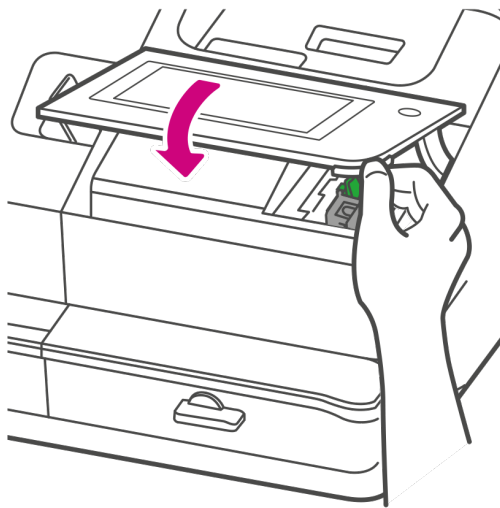

6

Connect the device to a power source

Connect the device to a power source. Tap the power button.

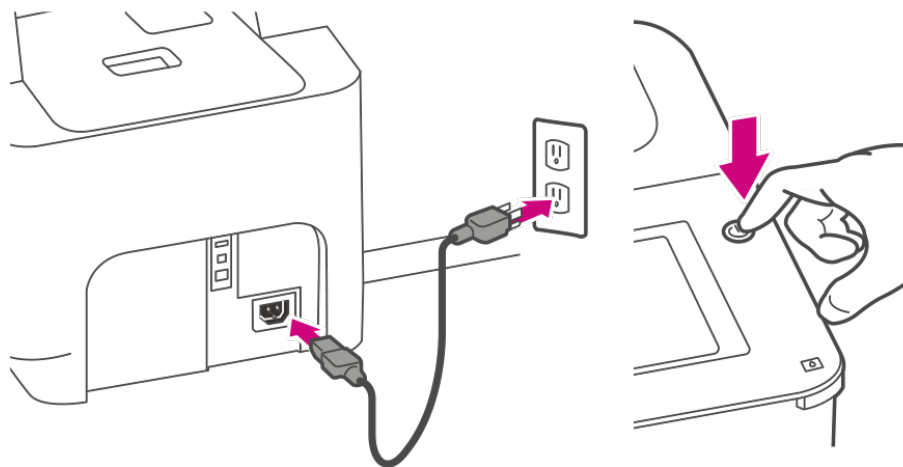

7 Follow the installation instructions on the device

1. Wait for the device to start up.
2. Tap **Get Started** on the touchscreen and continue the installation steps on the screen.



3. Tap **Got it** when you see the message "You're ready to start sending."

Installing a scale

Install a scale if you did not install one when you installed your device. Your device contains step-by-step installation instructions for compatible scales.

1. Tap **Settings**.



2. Scroll to the Advanced Device Options section at the bottom of the Settings screen, then tap **Scale Installation Guides**.

- To view all the available scales, swipe to the left on the screen.



- Tap to select the appropriate scale, then tap **Continue**.
- Follow the instructions on the screen. To advance to the next step, swipe the screen to the left.

Uploading system logs

Your device creates system logs that monitor operations on your device. If you need to upload system logs to a Pitney Bowes support representative, you can find them in the Advanced Device Options section under Settings.

- Tap **Settings**.



- Scroll down to the Advanced device Options section.
- Tap **System Log Upload**.
- Select the logs you want to upload.

5. Tap **Upload Selected Logs**.

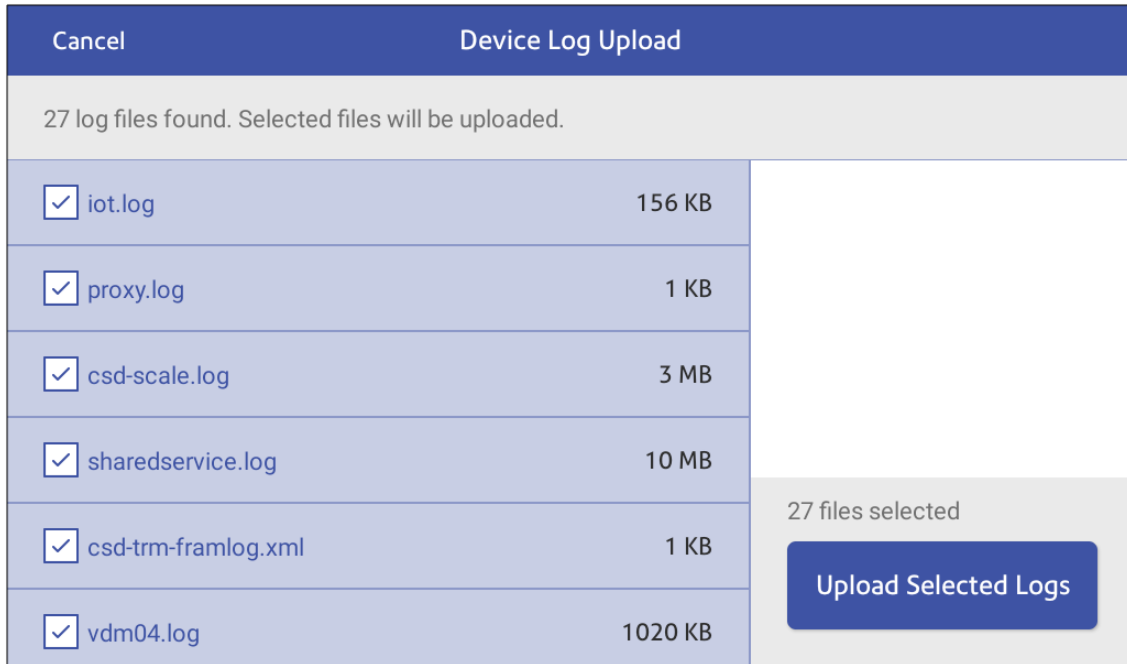

- 6. The message **Sending Log Files** appears. Once the upload is complete, the message **Upload Complete** appears.
- 7. Tap **Got It** to return to the Home screen.

4 - Printing Shipping Labels

In this section

Signing in to and out of the Create Shipping Labels app.....	75
Printing a shipping label.....	75
Comparing rates when printing a shipping label.....	82
Creating a new sender address for shipping labels.....	89
Editing the sender address for shipping labels.....	89
Printing an international shipping label.....	90
Printing a USPS return shipping label.....	101
Printing a USPS scan form.....	101
Reprinting a USPS, UPS or FedEx shipping label.....	102
Canceling a UPS or FedEx shipping label.....	103
Getting a USPS refund for a shipping label.....	103

Signing in to and out of the Create Shipping Labels app

In order to create and print shipping labels you need to sign in to your shipping labels account. You can also prevent unauthorised printing of labels by signing out of your account when you are away from your device.

Please note that the shipping application for the SendPro C devices does not support Single Sign On for PitneyShip Pro users.

Signing in

Tap **Create Shipping Labels** on the Home screen to sign in to the Create Shipping Labels app. You need to enter a name and password.

Signing out

1. Tap the user profile icon in the upper right corner of the toolbar to sign out of shipping labels.



2. Select **Sign out**.

Printing a shipping label

Use Create Shipping Labels to get the best pricing, free tracking, and detailed delivery history for USPS package services. You can also send via UPS® or FedEx®. The packaging options and benefits are almost identical.

Printing Shipping Labels

1. Tap **Create Shipping Labels** on the Home screen.
2. Tap the carrier you wish to use.

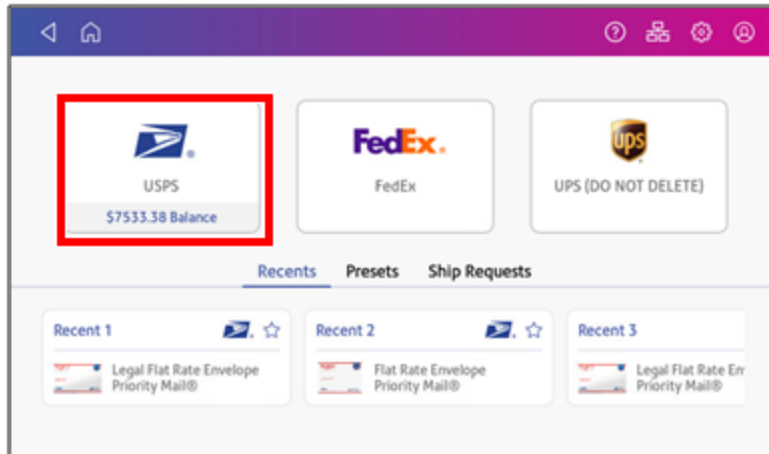

3. Verify that the sender address is correct. If not, tap on the **Sender** field and select a new address.

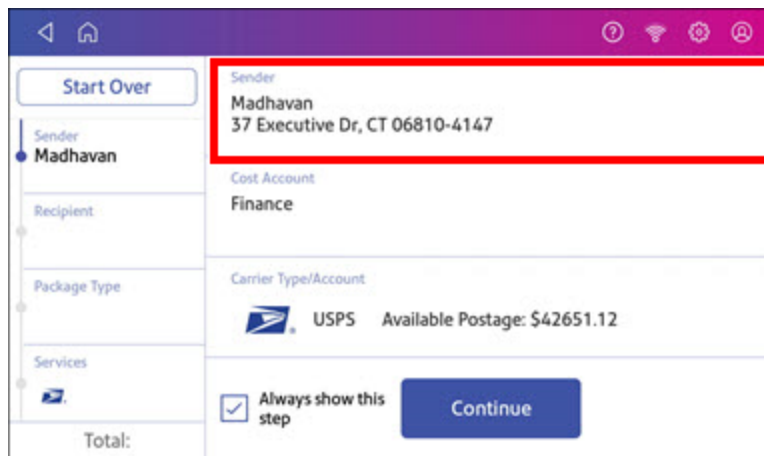

4. Select an account if cost accounts are enabled. Verify the selected cost account. Tap **Cost Account** and select an account to change or add the account..

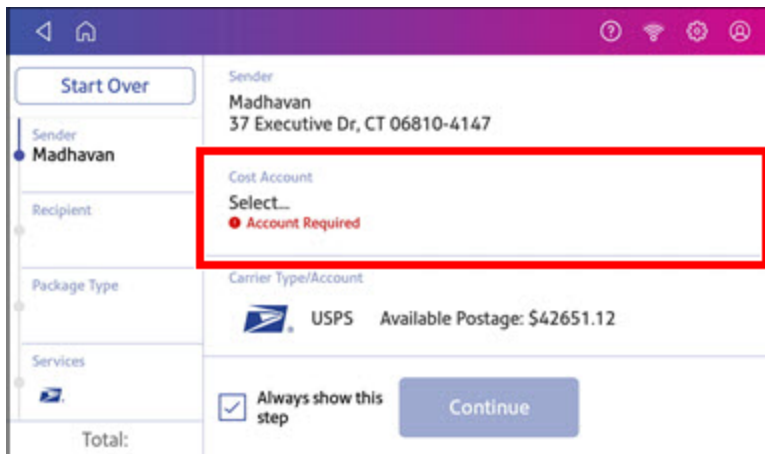

5. Tap **Continue**.

6. Enter the recipient address manually or tap **Address book** to select one from the address book.

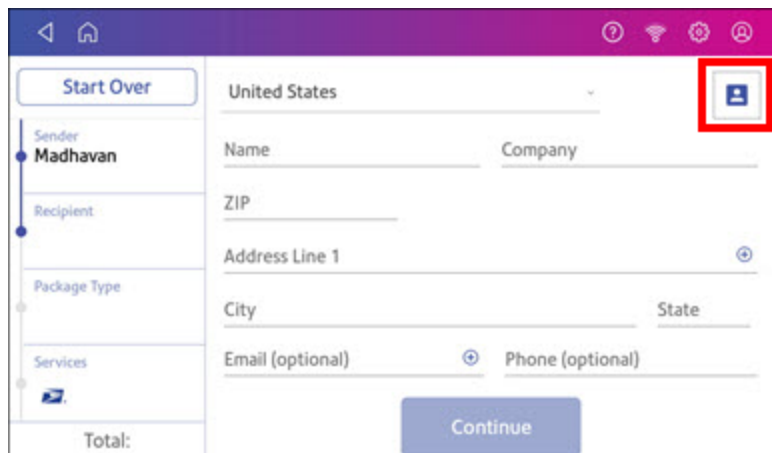

7. Tap **Continue**.
8. Tap a package type.

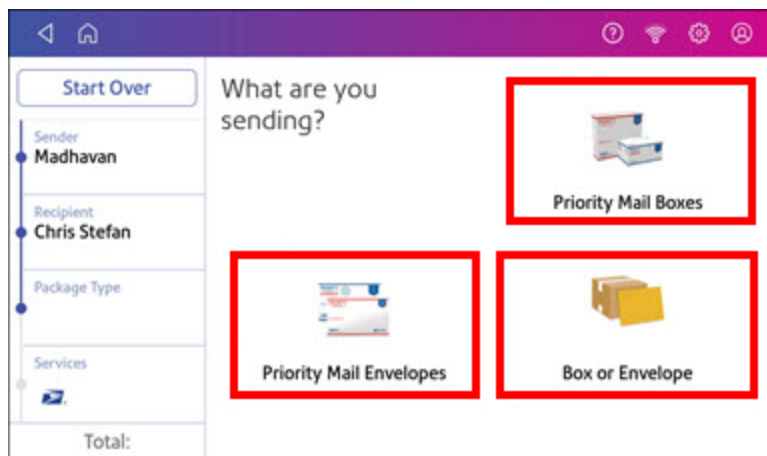

9. Enter the dimensions and weight of the package:
 - Tap each dimension and enter a value. Tap the green check mark when done.
 - If you have an attached scale, place the package on the scale and tap **Weight**. Tap **Scale** and the weight appears. Tap **Apply**.
 - If you do not have a scale, tap **Weight** and enter the weight, then tap **Apply**.

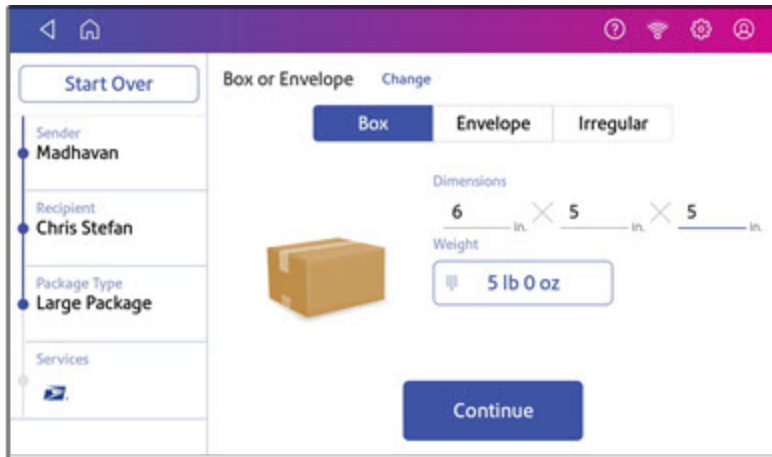

10. Tap **Continue**.
11. Tap the service you wish to use.

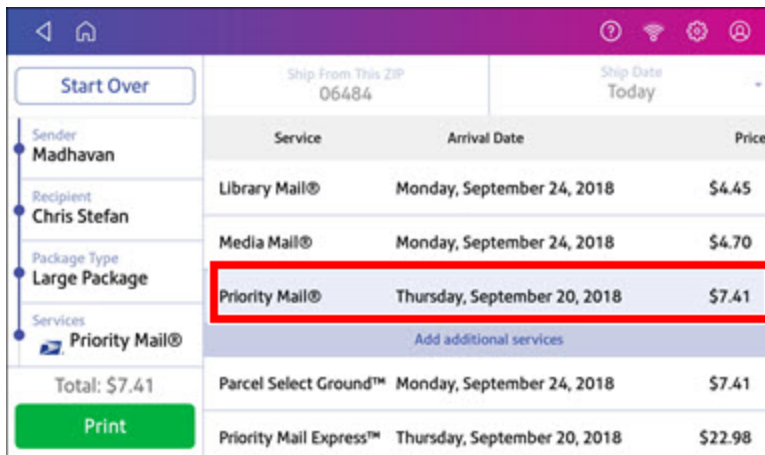

- To add additional services, tap **Add additional services**. If you are not adding any extra services, go to step 14.

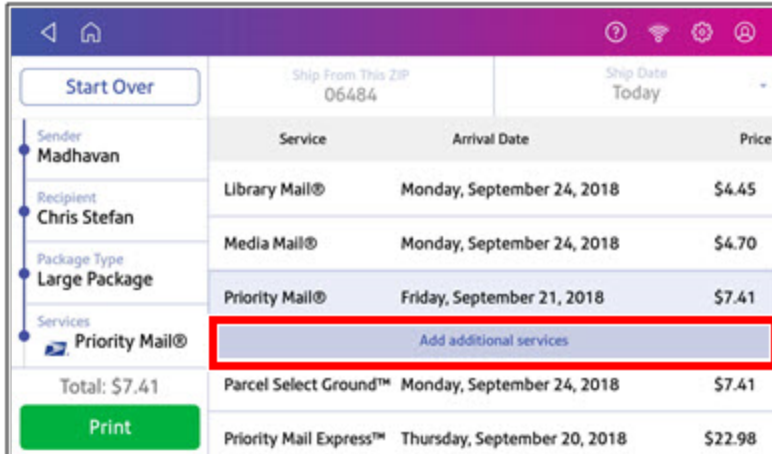

- Select the desired services and tap **Apply**.

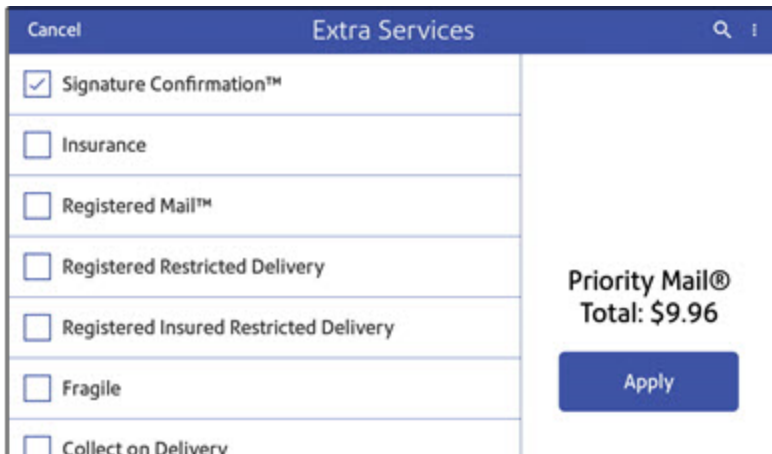

- To print the label, tap **Print**.

15. On the Label Options screen, tap **Format** and select the printer format.

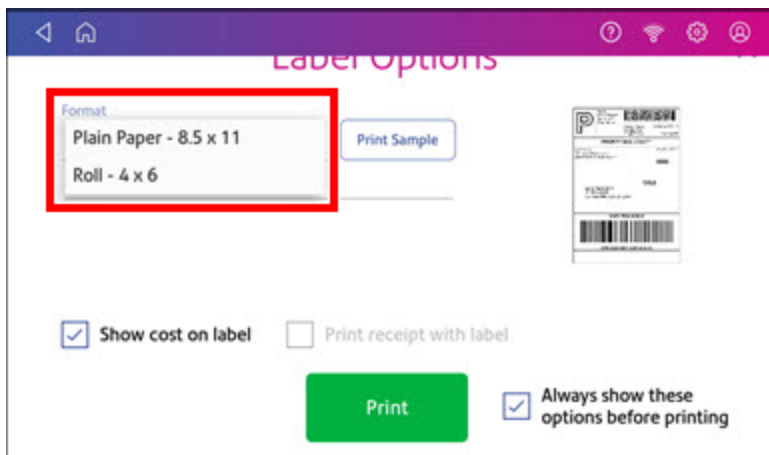

16. (Optional) Tap **Print Sample** to print a sample label.
17. Tap **Print** again and the label prints.
 - You may need to enter the Sender and Recipient's phone number, as it is required for some services.
18. The carrier screen reappears.

Comparing rates when printing a shipping label

If you have SendPro application software version 2.0.061R or later, your system allows you to compare the shipping rates of different carriers for every mailpiece or package.

1. Tap **Create Shipping Labels** on the Home screen.
2. Tap the carrier you wish to use.

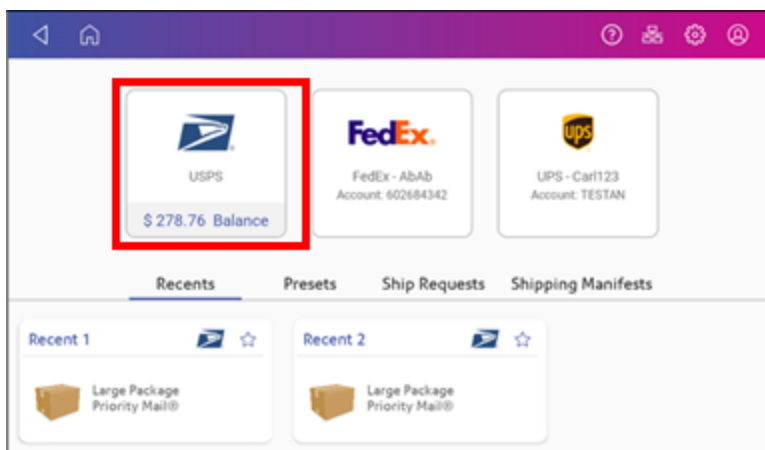

3. Verify that the sender address is correct. If not, tap on the **Sender** field and select a new address.

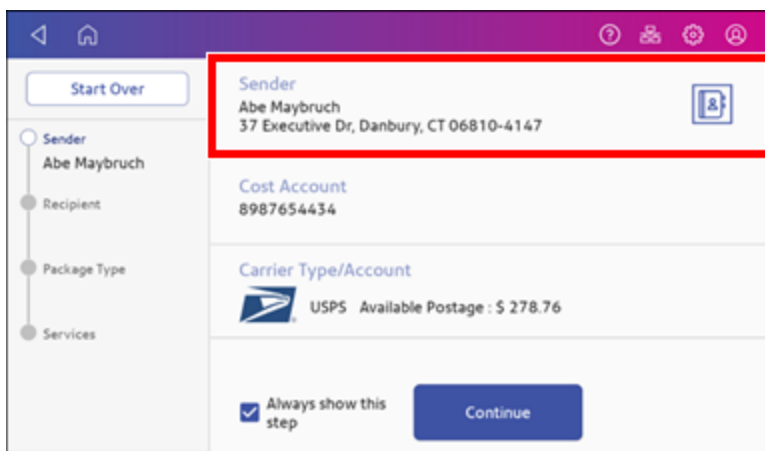

- If cost accounts are enabled, you must select an account. If an account is already present, verify that it is correct. To change or add the account, tap **Cost Account** and select an account.

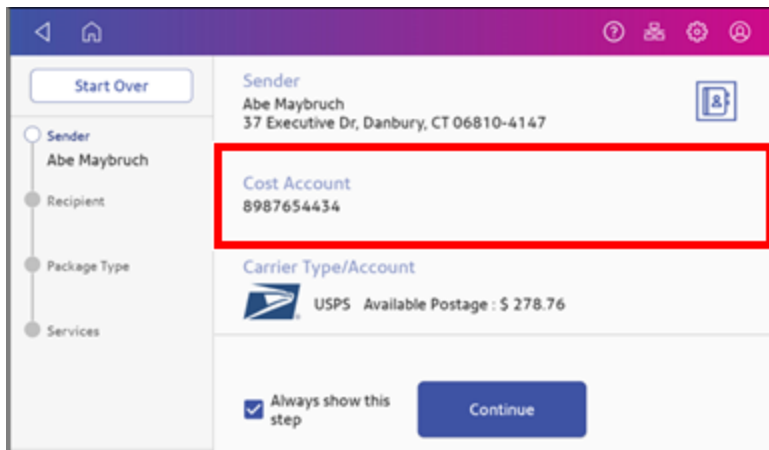

- Tap **Continue**.

6. Enter the recipient address manually or tap **Address book** to select one from the address book.

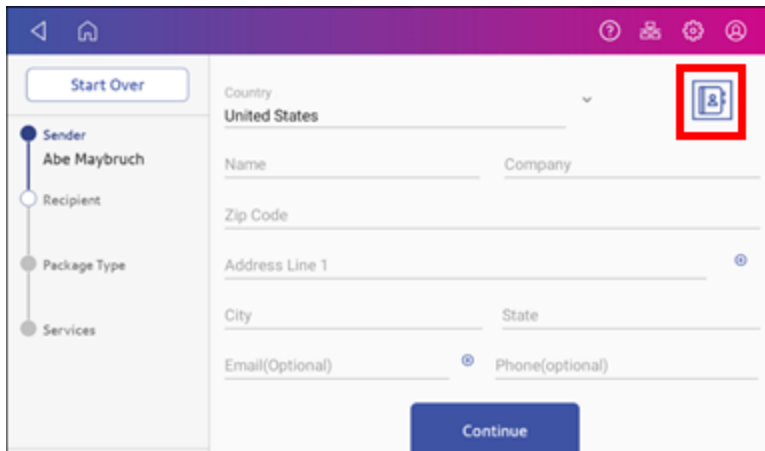

The screenshot shows a mobile application interface for creating a shipping label. On the left, a vertical progress bar indicates the current step is 'Recipient'. The main form area contains the following fields: 'Country' (United States), 'Name' and 'Company' (empty), 'Zip Code' (empty), 'Address Line 1' (empty), 'City' and 'State' (empty), and 'Email(Optional)' and 'Phone(optional)' (empty). A blue 'Continue' button is at the bottom. A red box highlights the 'Address book' icon in the top right corner.

7. Tap **Continue**.

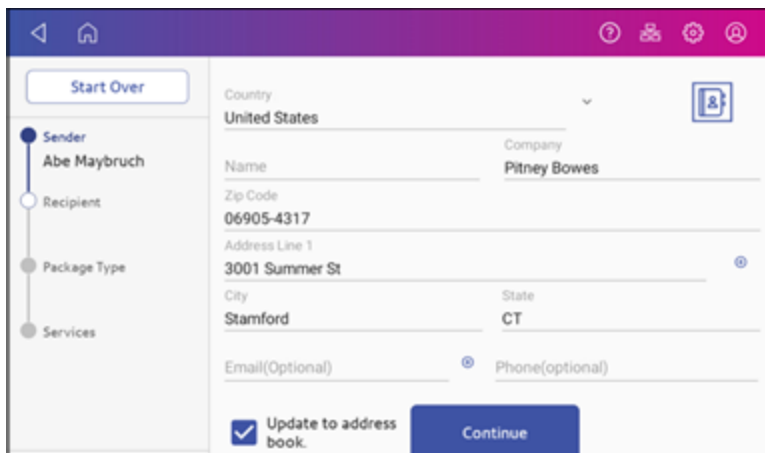

The screenshot shows the same mobile application interface as above, but now the 'Address book' icon is highlighted with a red box. The form fields are populated with the following information: 'Country' (United States), 'Company' (Pitney Bowes), 'Zip Code' (06905-4317), 'Address Line 1' (3001 Summer St), 'City' (Stamford) and 'State' (CT), and 'Email(Optional)' and 'Phone(optional)' (empty). A blue 'Continue' button is at the bottom. A checkbox labeled 'Update to address book.' is checked.

8. Tap a package type.

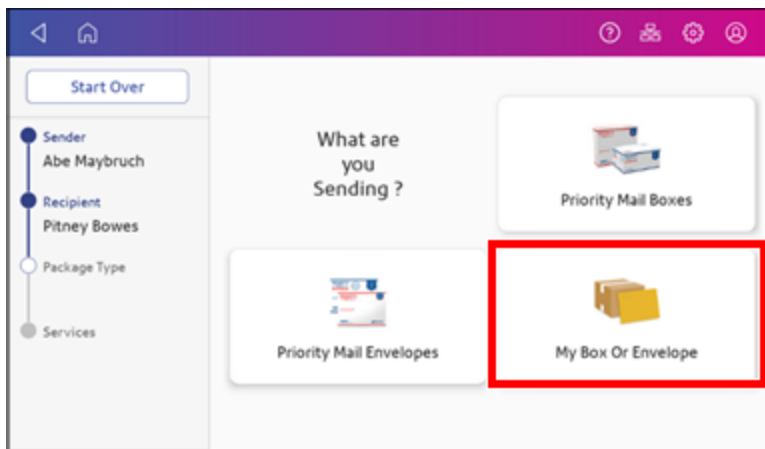

9. Enter the dimensions and weight of the package:

- Tap each dimension and enter a value. Tap the green check mark when done.

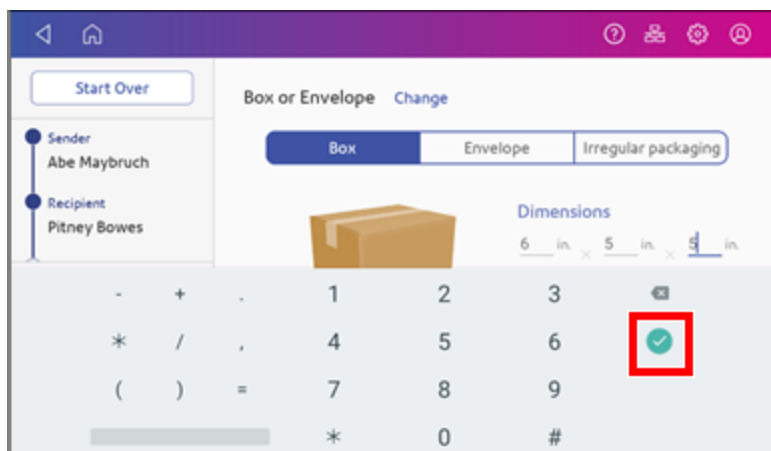

- If you have an attached scale, place the package on the scale and tap **Weight**. Tap **Scale** and the weight appears. Tap **Apply**.
- If you do not have a scale, tap **Weight** and enter the weight, then tap **Apply**.

10. Tap **Continue**.

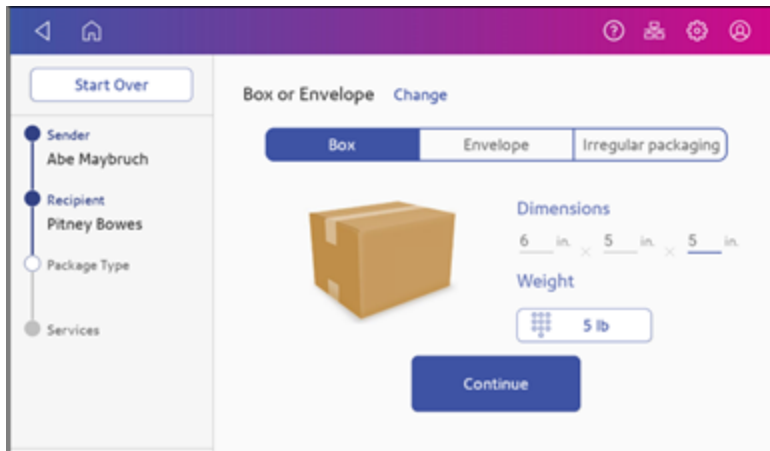

The system displays a list of the available carriers along with their estimated delivery dates and the total cost to send the package. Scroll down the screen to view all the carriers and their rates.

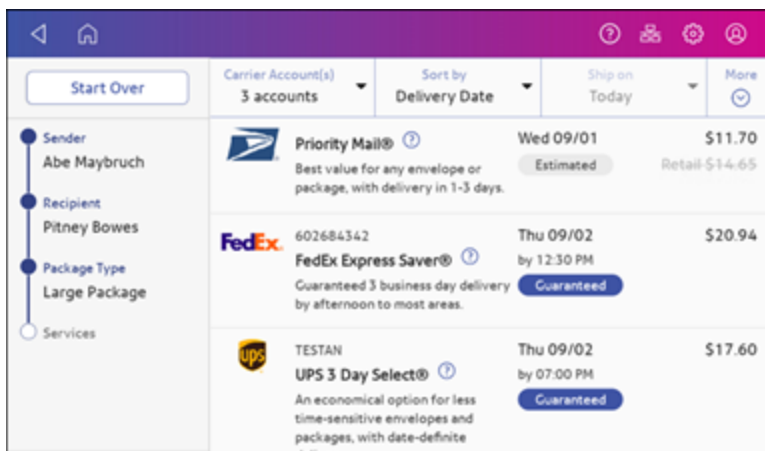

11. Tap the carrier you want to use. This example uses Priority Mail.

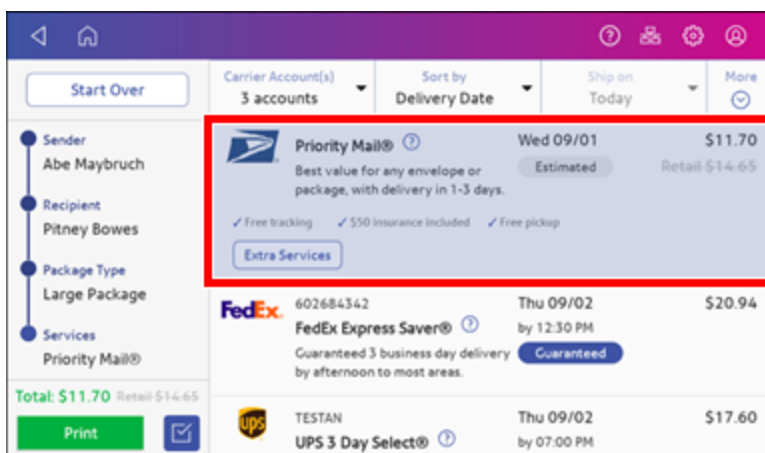

- To add additional services, tap **Extra Services**. If you are not adding any extra services, go to step 14.

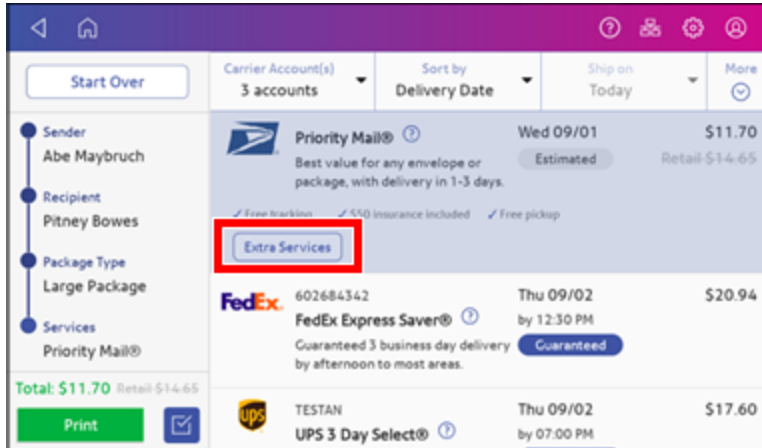

- Select the desired service or services.

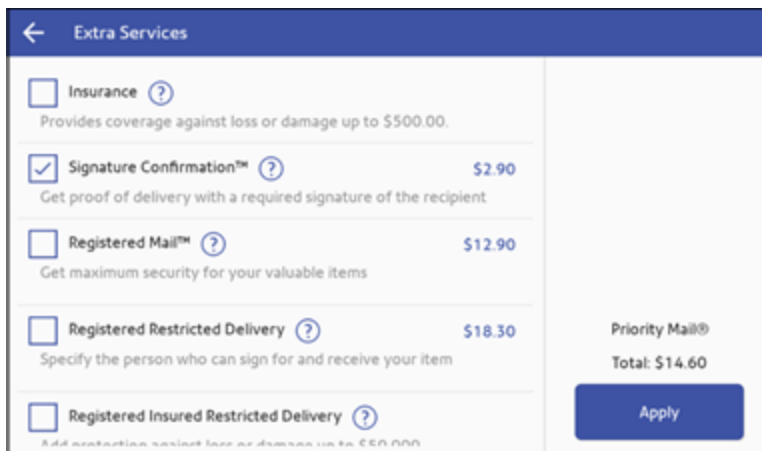

- Tap **Apply**. The system displays the total cost including the additional service.

15. Tap **Print** to print the label.

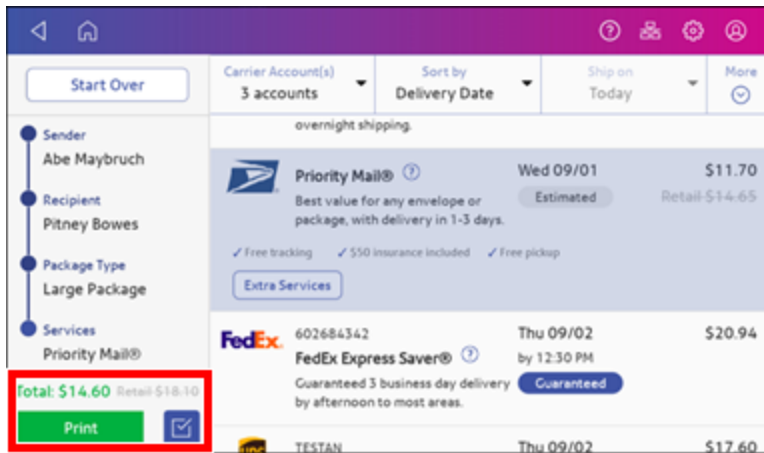

16. Tap **Format** and select the label size.

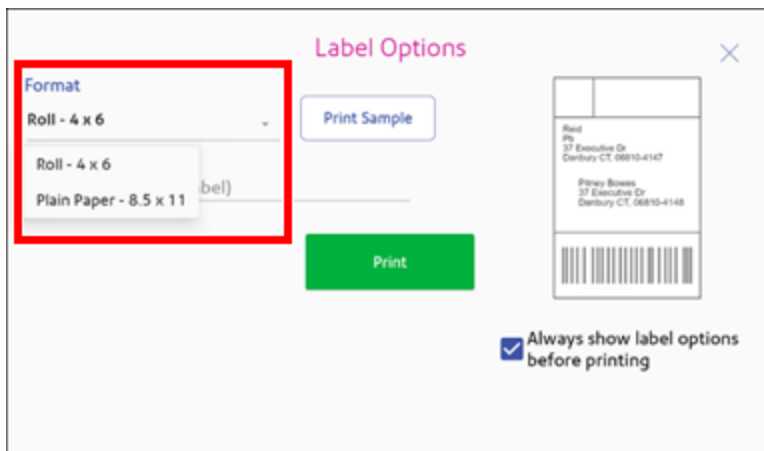

17. (Optional) Tap **Print Sample** to print a sample label.

18. Tap **Print** again and the label prints.

- You may need to enter the Sender and Recipient's phone number, as it is required for some services.

Creating a new sender address for shipping labels

If you need to ship from more than one address, you can add additional sender addresses to the Address Book.

1. Open the Address Book screen:
 - Tap **Address Book** at the bottom of the Home screen, or
 - Tap **SendPro Apps** on the Home screen, then tap **Address Book**.
2. Tap **Recipients** and select **Senders**.
3. Tap **+**.
4. Enter the sender information.
5. When complete, tap **Save**.

Editing the sender address for shipping labels

If you need to change a sender address, you can edit it in the address book.

1. Tap **SendPro Apps** on the Home screen, then tap **Address Book**.
2. Tap **Recipients** and select **Senders**.
3. Select the sender you wish to edit.
4. Tap **Edit**.
5. Make your changes and tap **Save**. The address book appears.

Printing an international shipping label

Printing an international shipping label is similar to printing a domestic shipping label. The main difference is adding the information required for customs purposes. You must declare package contents for U.S. customs when shipping internationally and to military mail.

To print a shipping label, follow the steps in each section below.

1. *Before you begin*
2. *Select the carrier*
3. *Add the sender and recipient addresses*
4. *Select the package type and enter the dimensions*
5. *Enter the type of items in the shipment*
6. *Select Exemption type*
7. *Add Customs information*
8. *Select the shipping services required*
9. *Print the shipping label*

1

Before you begin

In order to print an international shipping label with customs form from your device, you need to connect it to an 8.5 x 11 1E50 or 1E60 laser printer.

If you do not have a 1E50 or 1E60 laser printer, you print an international label from your SendPro Online or PitneyShip account using any 8.5 x 11 printer.

2 Select the carrier

- 1. Tap **Create Shipping Labels** on the Home screen.
- 2. Tap the carrier you wish to use.

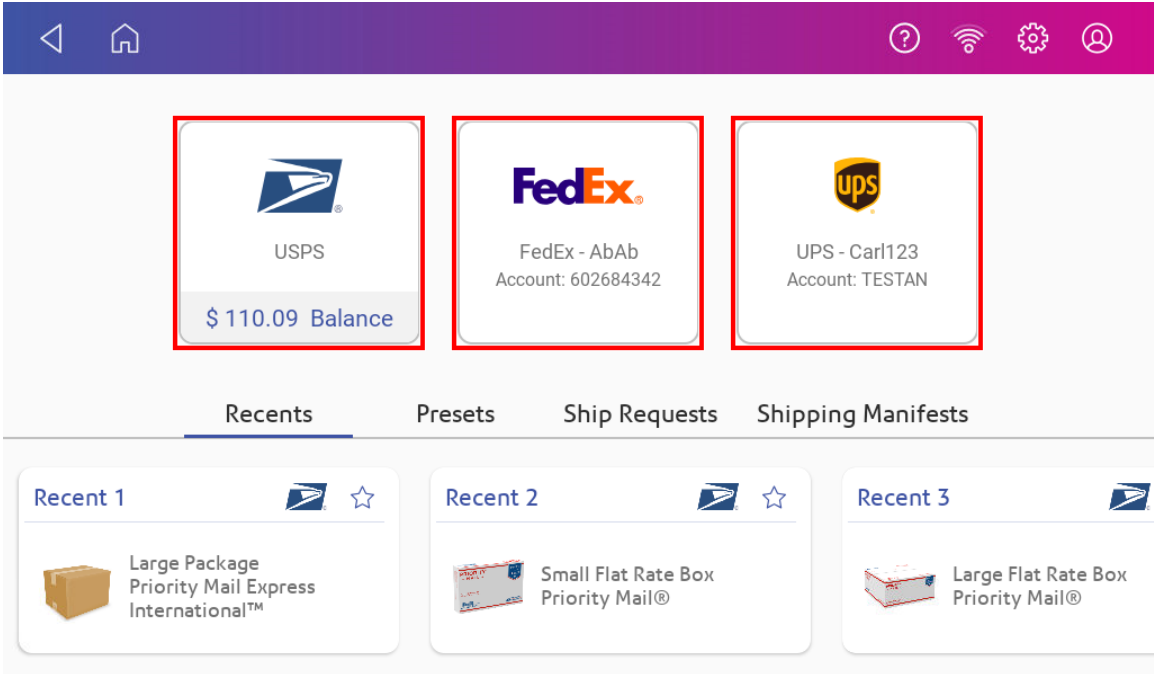

3 Add the sender and recipient addresses

1. Verify that the sender address is correct. If not, tap on the **Sender** field and select a new address.

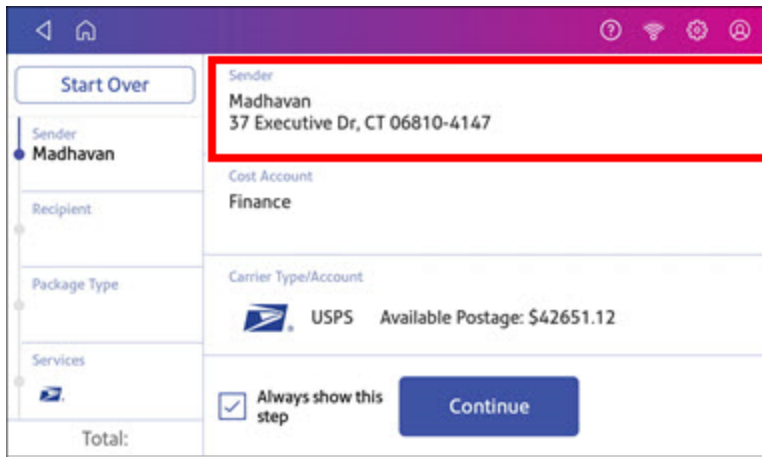

2. Select an account if cost accounts are enabled. Verify the selected cost account. Tap **Cost Account** and select an account to change or add the account.

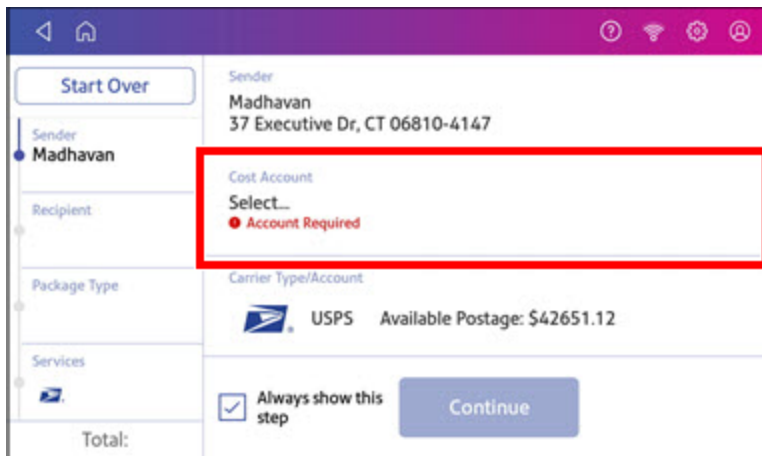

3. Tap **Continue**.

4. Enter the recipient address manually or tap **Address book** to select one from the address book.

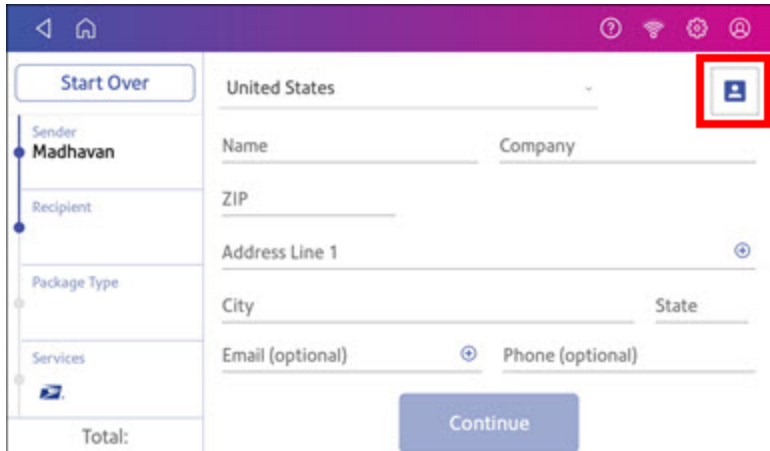

5. Tap **Continue**.

4 Select the package type and enter the dimensions

1. Select the package type.

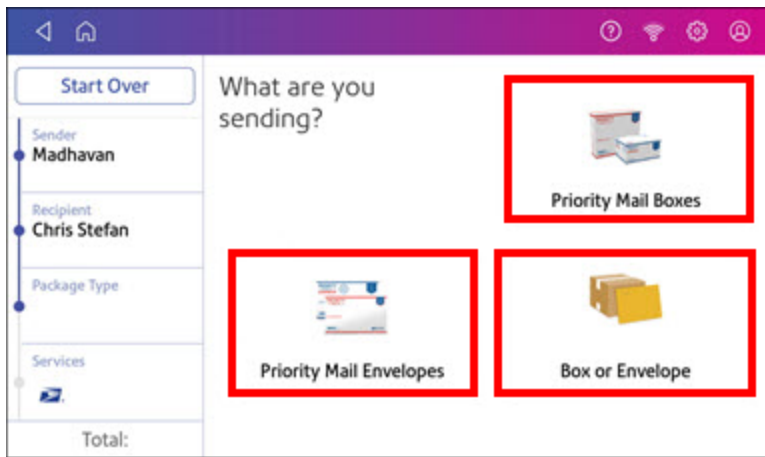

2. Enter the dimensions and weight of the package:
 - Tap each dimension and enter a value. Tap the green check mark when done.
 - If you have an attached scale, place the package on the scale and tap **Weight**. Tap **Scale** and the weight appears. Tap **Apply**.
 - If you do not have a scale, tap **Weight** and enter the weight, then tap **Apply**.

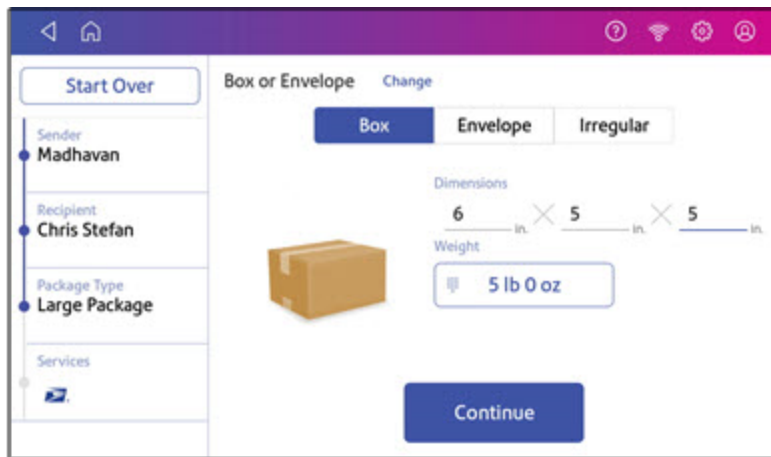

3. Tap **Continue**.

5 Enter the type of items in the shipment

1. Enter the type of items included in your shipment, in this example Documents.

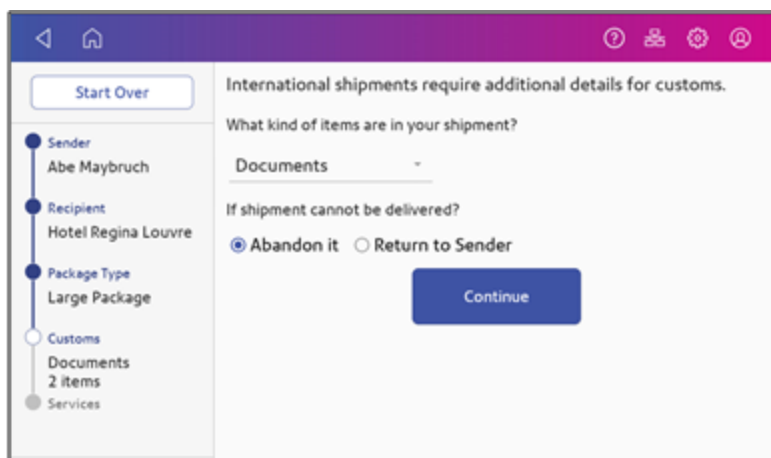

2. Select either **Abandon it** or **Return to Sender** if the item cannot be delivered.

3. Tap **Continue**.
4. Tap **Add an Item**.

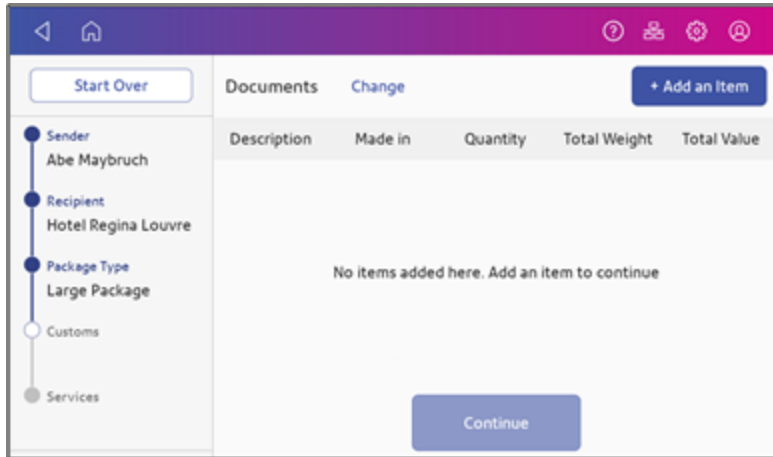

5. Enter a description of each item, including the quantity, weight, value and where the item was made.

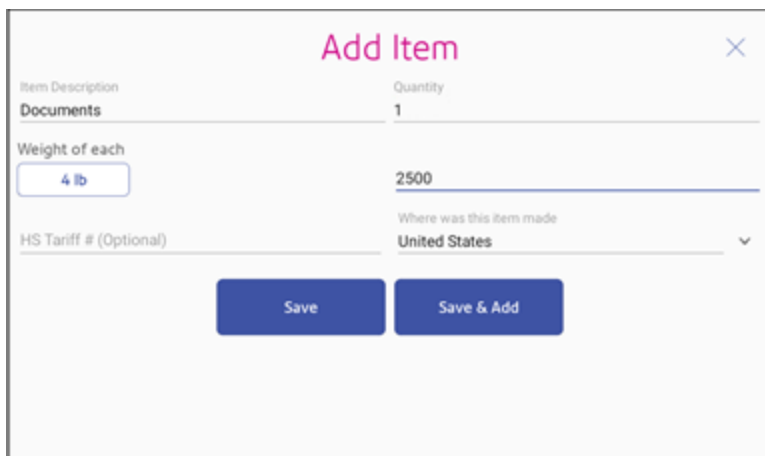

6. If appropriate, enter optional HS Tariff information.
7. To add additional items, tap **Save and Add**.
8. Tap **Continue**.

6 Select Exemption type

1. Tap **Select Exemption Type** and select the appropriate value.

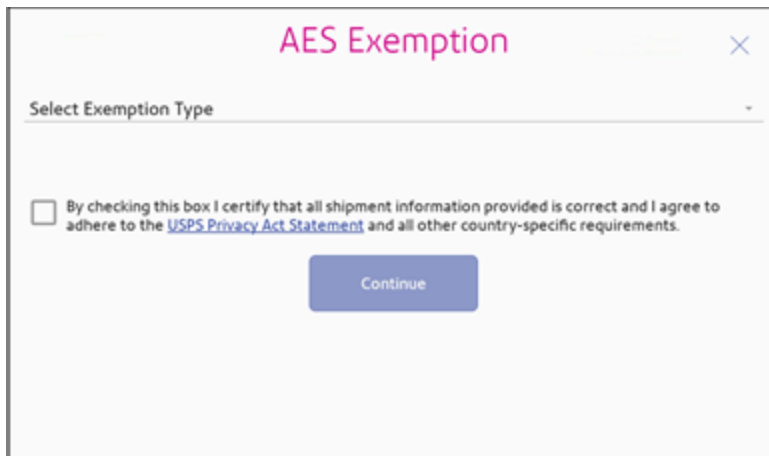

For further information, refer to the [USPS.COM Postal Explorer](#).

2. Tap on the checkbox to agree to the USPS Privacy Act Statement.

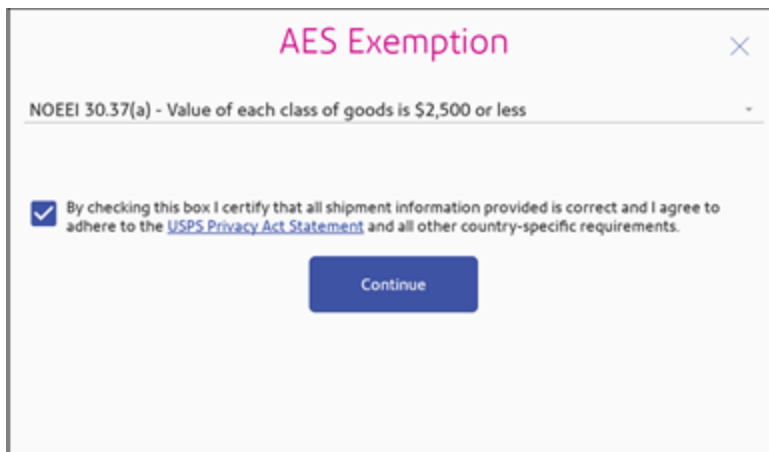

3. Tap **Continue**.

7 Add Customs information

1. (Optional) Add any additional customs information you have in the fields provided.
2. Tap **Continue** when done.

European Union (EU)

If you are shipping to a country that is part of the EU, you can collect, declare, and pay the import VAT tax to the authorities instead of making the recipient pay the import VAT tax when the items are imported into the EU.

If you have registered with the Import One-Stop Shop (IOSS) portal you can include your IOSS number with your additional customs information. Your device must have SendPro application software version 2.0.061R or later to use this feature.

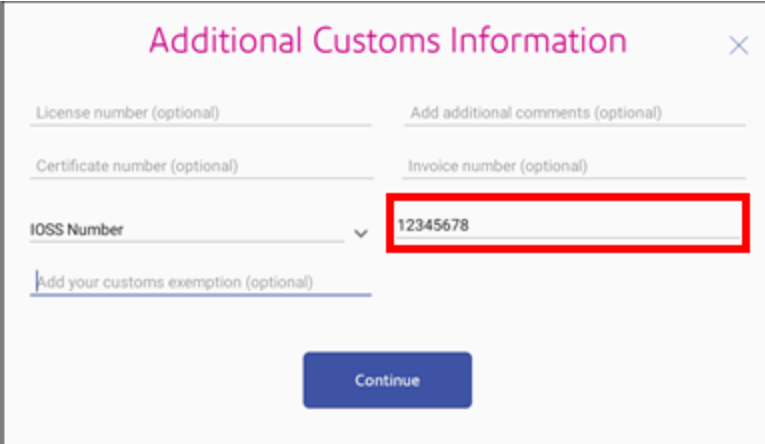

Additional Customs Information ×

License number (optional) Add additional comments (optional)

Certificate number (optional) Invoice number (optional)

IOSS Number ▼ 12345678

Add your customs exemption (optional)

Continue

For more information about the IOSS, visit the [IOSS page](#).

8 Select the shipping services required

1. Tap the service you wish to use.

Carrier/Account	Sort by	Ship on	More
USPS	Delivery Date	Today	⌵
Priority Mail Express International™ ⓘ		Sun 04/10	\$66.93
Fastest USPS service with delivery in 3-5 business days.		Estimated	Retail \$68-95
Priority Mail International® ⓘ		Fri 04/15	\$49.59
Best value for any envelope or package, with delivery in 6-10 business days.		Estimated	Retail \$52-20
First-Class Package International Service™ ⓘ		Tue 04/19	\$15.34
Most economical way to send lightweight packages, with delivery in 1-3 weeks.		Estimated	

2. To add additional services, tap **Extra Services**.

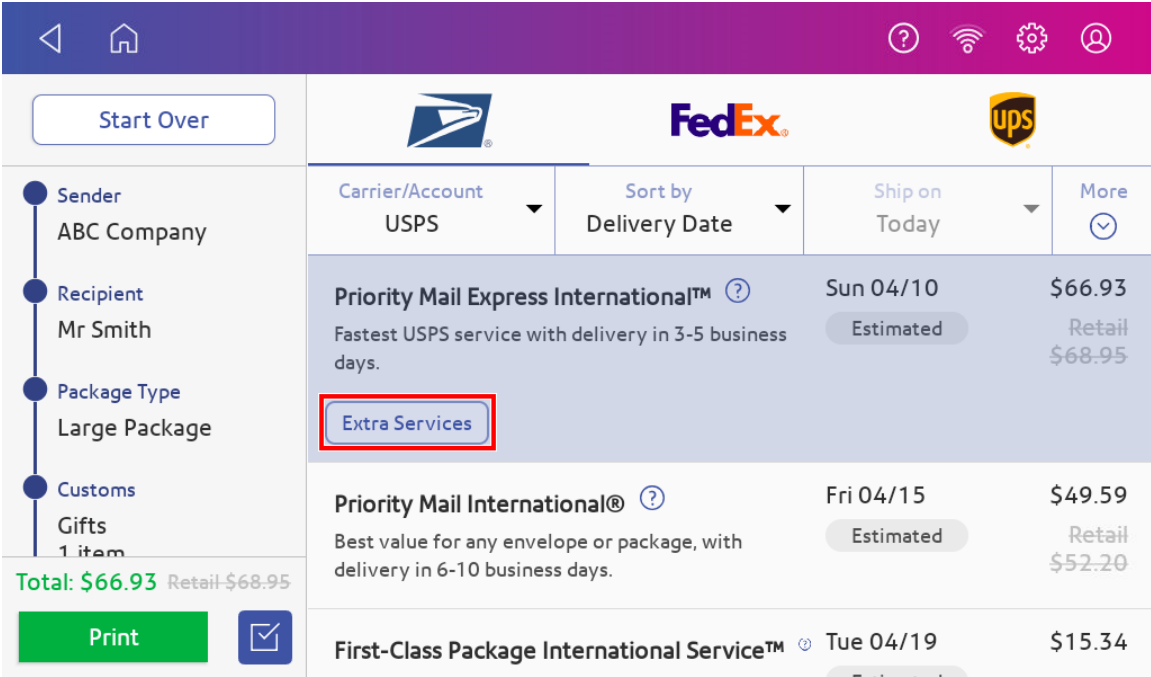

3. Enter the value of the item. Tap **Apply** when complete.

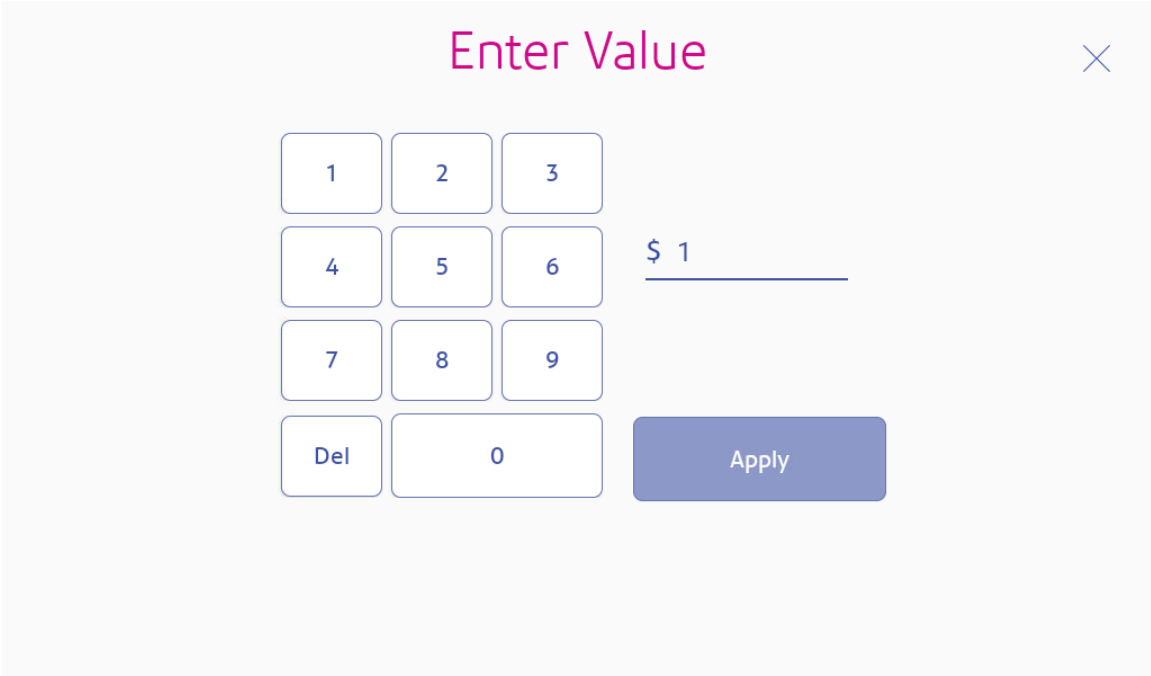

4. Select the desired services and tap **Apply**.

← Extra Services

Insurance ⓘ Included

Provides coverage against loss or damage up to \$1.00.

Value

Priority Mail International®

Total: \$49.59

Apply

9 Print the shipping label

1. To print the label, tap **Print**.
2. (Optional) On the Label Options screen, tap **Print Sample** to print a sample label.
3. Tap **Print** again and the label prints. You may need to enter the Sender and Recipient's phone number, as it is required for some services.
4. The carrier screen reappears.

Printing a USPS return shipping label

If you need to provide a USPS return label for someone to ship something back to you, you can print a return label.

1. Tap **SendPro Apps** on the Home screen, then tap **Shipping History**. All of the shipping labels appear by date. The most recent date appears first in the list.
2. Find your label in the list or by using the search box.
3. Tap on the shipment.
4. Tap **Create Return Label**.
5. Tap **Continue** through the screens to confirm the Sender and Recipient name and address.
6. If necessary, confirm the size and weight of the item.
7. Continue with Printing a shipping label.

Printing a USPS scan form

The purpose of USPS Shipment Confirmation Acceptance Notice (SCAN) Form 5630 is to save time. Without SCAN Form 5630, the USPS needs to scan each individual shipping label. This can be time consuming if there are a large number of shipping labels. Instead of scanning each individual shipping label, USPS scans the SCAN Form 5630 once and uploads every shipping label from that day to the USPS systems. The SCAN form must be enabled prior to printing any shipping labels that need to be included on a SCAN form.

In order to print USPS SCAN forms, you must enable the USPS SCAN Form Printing on your device.

Enabling USPS SCAN Form Printing on your device

1. Tap **Settings**.



2. Scroll down to Shipping Settings, then tap **Label Options**.

3. Scroll down to the SCAN Form and Manifest Printing section and tap on the **Enable SCAN form printing** box.
 - If you have an 8 1/2 x 11 1E50 Laser Report Printer that is either attached to one of the USB ports on the back of your device or connected through Wi-Fi, you can print the report from your device. Refer to [Printing from your device](#).

Printing from your device

1. Tap **Print on Envelopes** on the Home screen.
2. From the Carrier Home screen, tap **Shipping Manifests**.
3. Tap **USPS SCAN Form**. The number of shipments included in the manifest appear.
4. A preview of the manifest appears.



- a. To expand the view of the manifest, tap the expand icon.
- b. To change or select the printer, tap the device icon.
- c. To print the manifest, tap **Print** on the green bar at the bottom of the screen.

Reprinting a USPS, UPS or FedEx shipping label

If a label does not print correctly, you can print it again.

1. Tap **SendPro Apps** on the Home screen, then tap **Shipping History**. All of the shipping labels appear by date. The most recent date appears first in the list.
2. Locate your label in the list. To sort by a different column, tap that column heading. To reverse the sort order, tap the same column heading again.
3. Tap on the shipment.
4. Tap **Reprint Label**.

Canceling a UPS or FedEx shipping label

You can cancel a UPS or FedEx shipping label to stop the postage appearing on your UPS or FedEx invoice.

1. Open the Shipping History screen:
 - Tap **SendPro Apps** on the Home screen, then tap **Shipping History**.
2. All of the shipping labels appear by date. The most recent date appears first in the list.
3. Locate your label in the list. To sort by a different column, tap that column heading. To reverse the sort order, tap the same column heading again.
4. Tap the shipment to open the details screen.
5. Tap **Void Label**. Select the box to confirm that you will not be using the label, then tap **Continue**.

Getting a USPS refund for a shipping label

If your international package was returned by USPS due to COVID-19 restriction, you can request a refund through SendPro Online or PitneyShip within 45-days of the label creation date.

The refund process can take up to 20 days because USPS wishes see if it can detect your shipment in its mailstream before crediting your account.

Important: When you cancel a UPS or FedEx label, the credit will appear on your UPS or FedEx invoice.

1. Tap **SendPro Apps** on the Home screen, then tap **Shipping History**. All of the shipping labels appear by date. The most recent date appears first in the list.
2. Locate your label in the list. To sort by a different column, tap that column heading. To reverse the sort order, tap the same column heading again.
3. Tap on the shipment.

4. Tap **Request Refund**.
5. Select the box to agree to the conditions, then tap **Continue**.

Important: Labels for First-Class Large Envelope do not bear a tracking barcode. You cannot request a refund for them via the SendPro C Lite, SendPro C, SendPro+ device. Sign in to sendpro.pitneybowes.com to request a refund for these transactions.

If your international package was returned by USPS due to COVID-19 restrictions, you cannot request a refund through SendPro Online or PitneyShip. You must file a claim directly through USPS. Go to the [USPS International Claims](#) page and click on Create an Inquiry to file a claim. If approved, USPS will send you a check for the postage cost.

5 - Managing Shipping Labels

In this section

Using the Address Book.....	106
Changing the default refill amounts for shipping labels.....	106
Turning on address autofill for shipping labels.....	106
Adding new addresses to the shipping labels Address Book.....	107
Enabling Cost Accounts for shipping labels.....	107
Refilling postage for shipping labels.....	108
Setting an alert when shipping label postage refill is pending.....	109
Setting up your FedEx account.....	110
Setting up your UPS account.....	111
Setting up default printing options.....	112
Managing email notifications for shipping labels.....	113
Setting the default address for USPS return labels.....	114
Determining how you spend your shipping labels postage.....	114
Removing funds.....	114

Using the Address Book

The Address Book app allows you to add, edit, and delete addresses for everyone you ship to. Once you add an address to the Address Book app, you can select it when you print shipping labels.

To open the Address Book:

- Tap **SendPro Apps** on the Home screen, then tap **Address Book**.

Changing the default refill amounts for shipping labels

Change the default refill amount for shipping labels to store an amount you want to refill your device with.

1. Tap **Settings**.



2. Scroll to Shipping Settings.
3. Tap **Shipping Refills**.
4. Tap **Auto-refill Postage**.
5. Tap the box under **Default refill amount for trackable labels**.
6. Enter the amount.
7. Tap **Apply**.

Turning on address autofill for shipping labels

Autofill automatically fills in the address fields as you start to enter an address. This makes it easier to enter addresses when creating shipping labels.

1. Tap **Settings**.



2. Scroll down to **Shipping Settings**.

3. Tap **SendPro Experimental Features**.
4. Tap on the check box for **Use Geosearch**.

Adding new addresses to the shipping labels Address Book

Use the Address Book app on your device to add single addresses. Use SendPro Online or PitneyShip to import multiple addresses.

Adding a single address

1. Tap **SendPro Apps** on the Home screen, then tap **Address Book**.
2. Tap the **+** icon to add a new address and enter the contact information.
3. Tap **Save** when done.

Important: The maximum number of addresses that the Address Book can store is 1000.

Adding multiple addresses

To import multiple addresses to the Address Book on your device, use SendPro Online or PitneyShip. In your web browser, go to <https://login.pitneybowes.com/sendpro> and sign in with your SendPro C Lite, SendPro C, SendPro+ user ID and password.

Enabling Cost Accounts for shipping labels

Cost Accounts help you keep track of where you're spending your money on postage by allowing you to assign shipping label costs. You can also assign a Cost Account for postage refills.

The Cost Accounts feature is enabled via the SendPro Online® or PitneyShip™ shipping solution. Please access the SendPro Online or PitneyShip web application on your computer where you can also view Cost Accounts information.

Refilling postage for shipping labels

Your device uses two separate postage accounts. One is for shipping labels and one is for Print on Envelopes. You cannot use the shipping label funds for Print on Envelopes and vice versa.

Before you begin:

Check that your device is connecting to the internet.

- If you have a wired network connection, you will see the following connection icon in the toolbar:



- If you have a wireless connection, you will see the following connection icon in the toolbar:



To refill your shipping labels postage account:

1. Tap **Settings**.



2. Scroll down to **Shipping Refills**.
3. Tap **Shipping Refills**.

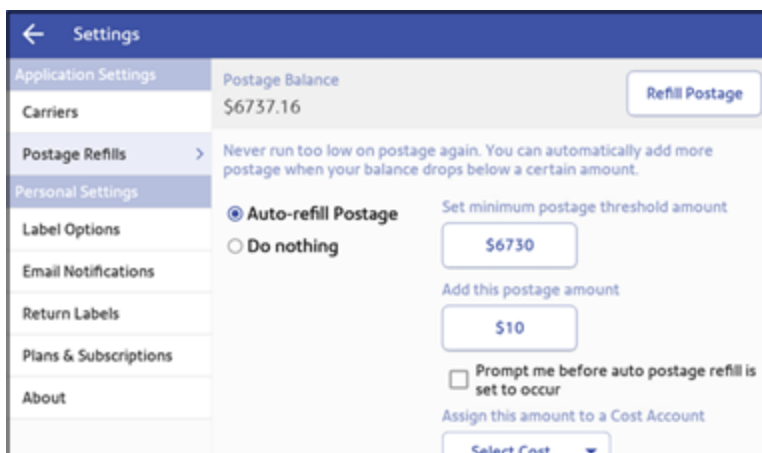

4. If you have enabled cost accounts for shipping labels, you must select a cost account. Tap **Select Cost** and choose an account from the drop-down list.
5. Tap **Refill Postage** on the upper right corner of the screen.
6. Use the numeric keypad to enter the amount you wish to refill.
7. Tap **Refill Postage**. When complete, the updated shipping label postage amount appears.
8. Tap **Home** to return to the Home screen.

Setting an alert when shipping label postage refill is pending

Arrange to have your device alert you when a shipping label postage refill is pending.

In order to set up the alert you must also define a minimum postage threshold amount.

To refill your shipping labels postage account:

1. Tap **Settings**.



2. Scroll down to **Shipping Refills**.
3. Tap **Shipping Refills**. The shipping label postage refill screen appears.

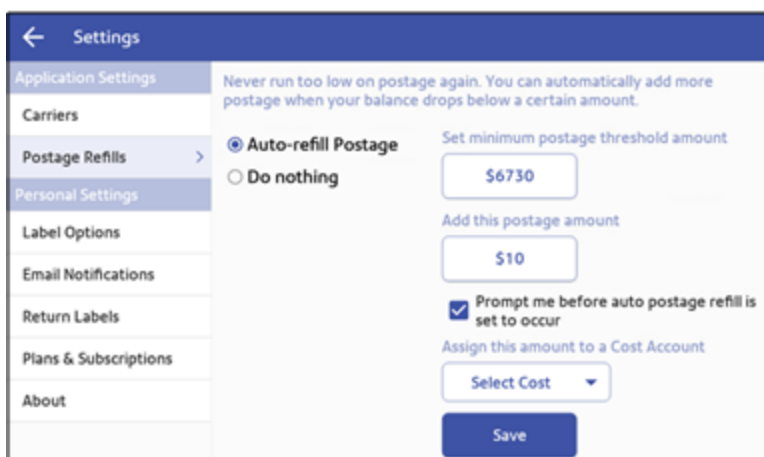

4. Scroll down on the screen until the **Save** button is visible.

5. Check that the minimum postage threshold amount is correct. If not, tap on the amount and enter the correct value.
6. If you have enabled cost accounts for Create Shipping Labels, you must select a cost account. Tap **Select Cost** and choose an account from the drop-down list.
7. Tap the **Prompt me before auto postage refill is set to occur** box.
8. Tap **Save**.
9. Tap the back arrow to return to the Home screen.

Setting up your FedEx account

Use SendPro Online® or PitneyShip™ to set up your FedEx account. You must do this before you use FedEx for shipping labels.

You cannot set up a FedEx account on your device. In your web browser, go to <https://login.pitneybowes.com/sendpro> and sign in with your SendPro C user ID and password.

Once you have set up your FedEx account using SendPro Online or PitneyShip, you can view and modify your account information on your device.

You can also take advantage of FedEx SmartPost®. This is a delivery service provided by FedEx for low-weight packages that allows you to select a USPS facility for the final delivery by a postal carrier.

Important: Be sure to contact FedEx to see if this service is available for your FedEx account.

1. Tap **Settings**.



2. Scroll down to **Shipping Settings**.
3. Tap **Carrier Settings**.

4. Tap **Manage** next to FedEx on the right side of the screen. The Manage FedEx Account screen appears.

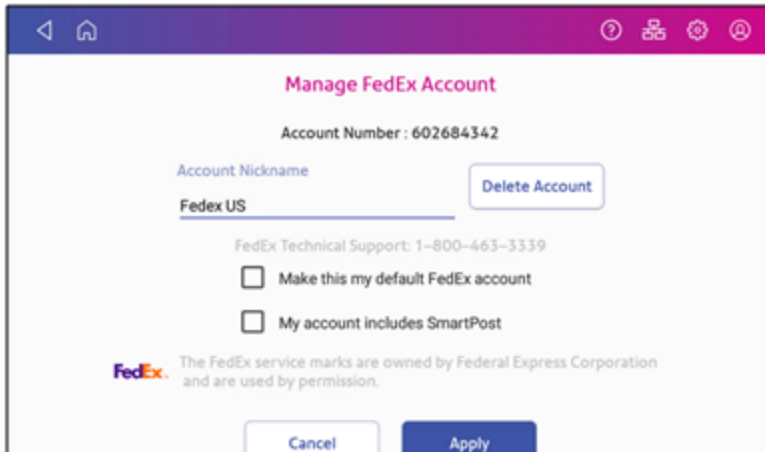

5. Tap the **Make this my default FedEx account** box to use this as your default FedEx account.
6. Tap the **My account includes SmartPost** box if your account includes SmartPost and you wish to use this service.

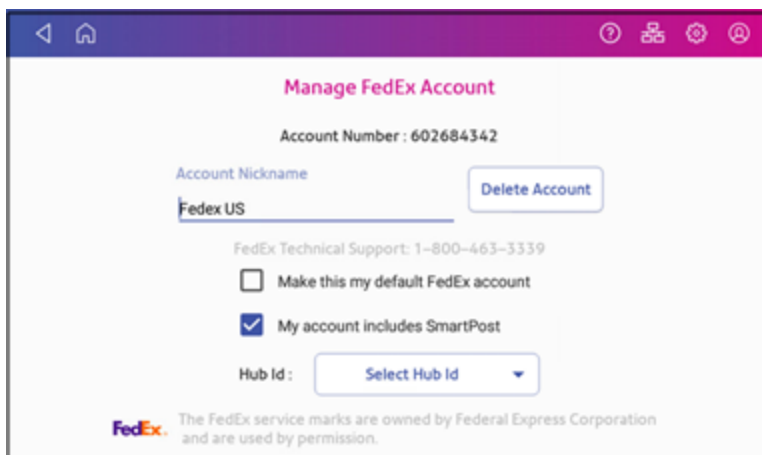

7. Tap **Select Hub Id** and select the appropriate carrier location from the drop-down list.
8. Tap **Apply** to confirm and save your selection.

Setting up your UPS account

Use SendPro Online or PitneyShip to set up your UPS account. You must do this before you use UPS for shipping labels.

You cannot set up a UPS account on your SendPro C Lite, SendPro C, SendPro+. In your web browser, go to <https://login.pitneybowes.com/sendpro> and sign in with your SendPro C Lite, SendPro C, SendPro+ user ID and password.

Once you have set up your UPS account using SendPro Online or PitneyShip, you can view your account information on your device:

1. Tap **Settings**.



2. Scroll down to **Shipping Settings**.
3. Tap **Carrier Settings**.
4. Tap **Manage** next to UPS.

Setting up default printing options

Define the print options for your shipping labels. This includes the label size and whether to print the cost on the label. You can also choose to print a receipt or enable scan form and manifest printing.

1. Tap **Settings**.



2. Scroll down to **Shipping Settings**.
3. Tap **Label Options**.
4. To enable print preview and label options before printing, tap the check box for **Always show label options before printing**.
5. To print a receipt with the label, tap the check box for **Print receipt with label**.
 - Only available with 8.5 x 11 format
6. To select the print format, tap **Format** and select one of the following:
 - Plain Paper - 8.5 x 11 (report printer only)
 - Roll - 4 x 6
7. To enable USPS scan form and manifest printing, tap the check box for **Enable scan form printing**. Enter the ZIP code for the location from where you are shipping on the line provided.

Managing email notifications for shipping labels

You can use email notifications to track shipments and to advise of delivery. You can also receive a notification when a shipping label refund has been issued.

There are three types of notifications:

- **Tracking Number Email:** Emails a tracking number for each new shipping label automatically.
- **Shipment Delivery Email:** Emails a delivery confirmation for each new shipping label automatically.
- **Refund notifications:** Emails a confirmation each time your postage balance receives a credit through a label refund.

1. Tap **Settings**.



2. Scroll down to **Shipping Settings**.

3. Tap **Automated Emails**.

4. Tap the required check boxes in the Tracking Number Email and Shipment Delivery Email sections to enable tracking number and delivery confirmation emails to senders or recipients.

5. To receive an email when your postage balance receives a credit through a label refund:

- Scroll down and enter the email address in the Email Confirmation for Postage Refund section.

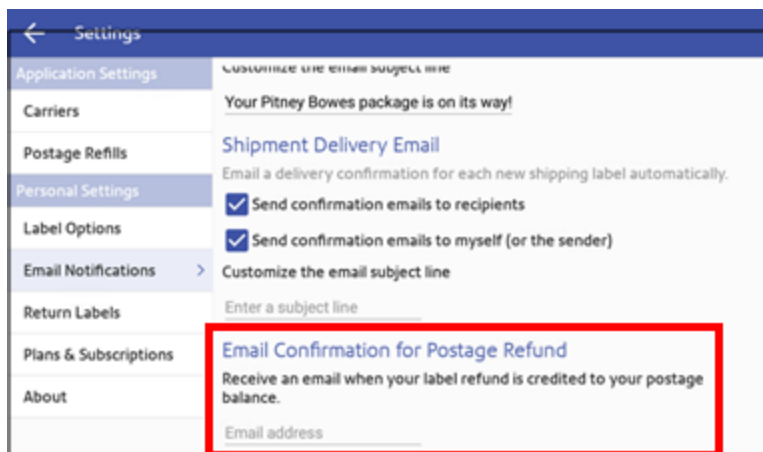

6. (Optional) To customize the subject for each email type, enter the subject in the Customize the email subject line field.

Setting the default address for USPS return labels

You can set the recipient's address as a default address for all of your USPS return labels.

1. Tap **Settings**.



2. Scroll down to **Shipping Settings**.
3. Tap **Return Labels**.
4. Tap the check box for **I wish to use the same recipient address for all of my return labels**.
5. Enter the address in the fields provided using the keypad on the screen. Tap the green check mark when done.

Determining how you spend your shipping labels postage

View the Shipment report to see how much postage you are spending. The report includes a list of all the shipping labels you have printed along with their carriers and the amounts of postage.

1. Tap **Settings**.



2. Scroll down to **Shipping Settings**.
3. Tap **Shipment Reports**.
4. To list by cost accounts, tap **Menu** next to All Shipments column. Tap **Summary by Cost Account**.

Removing funds

Important: Once you take your device out of service you will no longer be able to print postage on envelopes. The withdraw device button is disabled (greyed out) if the ink cartridge is not present. If the ink cartridge is not present, install it before taking the device out of service.

1. Tap **Settings**.



2. Tap **Withdraw device**.
3. Enter code **6184**.
4. Tap **Withdraw Device**.

Before returning your device please remove the ink cartridge:

1. Tap **Settings**.



2. Tap **Envelope Printer Maintenance**.
3. Tap **Install Ink**.
4. Open the top cover.

5. Open the ink door and remove the ink cartridge.

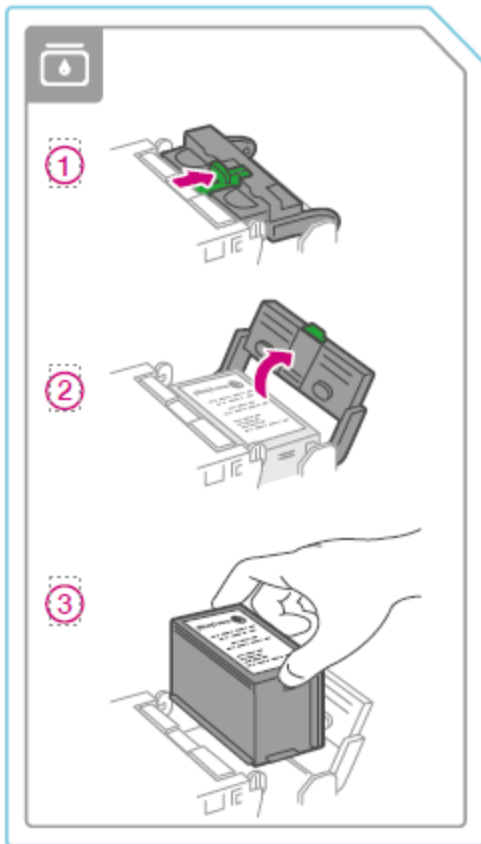

6. Close the ink door and close the top cover.

Follow the instructions in your return kit to properly package and return your device.

If you need to remove funds from your shipping account, please chat with us.

Important: If your device is inoperable or you are unable to withdraw or transfer your funds back to their original funding source, please chat with us.

6 - Printing on envelopes

In this section

Navigating the Print on Envelopes app.....	118
Checking the available funds for printing postage.....	119
Adding or refilling postage for printing on envelopes..	121
Sending a First-Class Mail envelope.....	122
Sending a large First-Class® envelope.....	123
Sending Certified Mail.....	124
Sending an international letter.....	125
Sending mail using a Certificate of Mailing.....	125
Advancing the date.....	127
Printing postage without a date for pre-printed mailpieces.....	127
Printing additional postage.....	128
Re-dating your mail.....	129
Using USPS special services.....	130
Entering the weight manually when printing postage..	130
Using the scale when printing postage.....	131
Sealing envelopes without printing postage.....	132
Sealing envelopes when you print postage.....	133
Zeroing the scale.....	135
Adding insurance to your mail.....	136
Adding a graphic to your envelope or tape.....	137
Sending mail using Electronic Return Receipt (ERR)..	137
Getting a USPS refund for damaged or incorrectly printed mail.....	138
Creating a custom text message for your mail.....	139
Adding a custom text message to your envelope or tape.....	141
Editing or deleting a custom text message.....	143

Printing a graphic without printing postage..... 145
 Adding an inscription..... 146
 Printing only the date and time..... 146

Navigating the Print on Envelopes app

The Print on Envelopes app is the starting point for printing postage on an envelope or a tape. It also allows you to change what you print.

To open the Print on Envelopes app, tap **Print on Envelopes**.

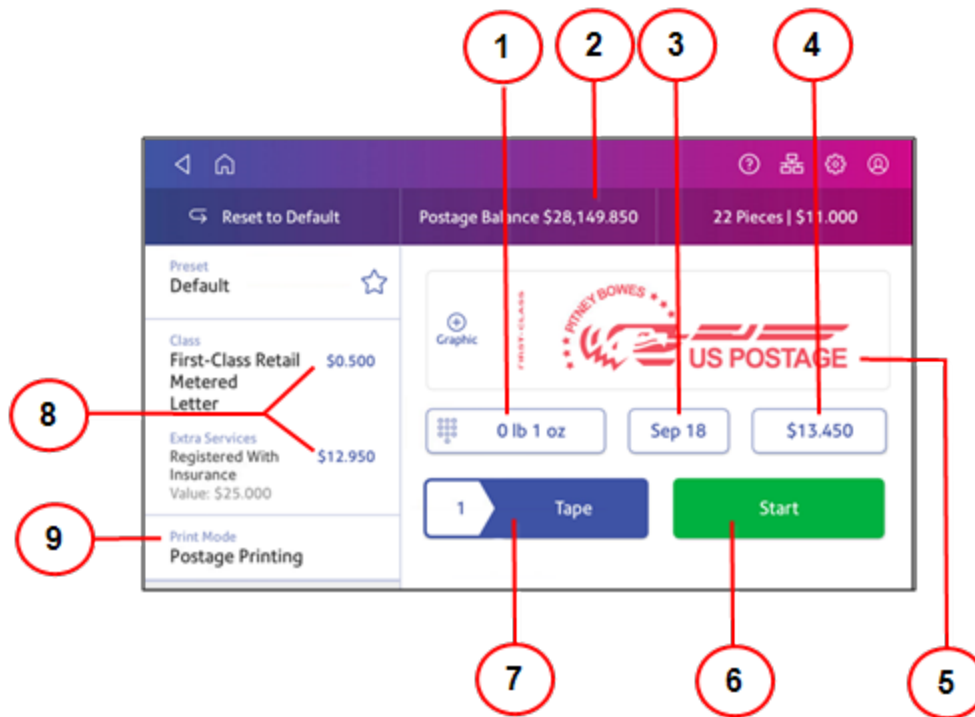

On this screen, you can:

1. Tap the weight to view the weighing options. You can enter the weight manually or use a scale.
2. View the balance of funds you have remaining in your device.
3. Tap the date to view the date options.
4. View the total postage amount.
5. Preview or add graphics.

6. Tap **Start** to begin feeding and printing postage on the envelopes loaded on the feed deck. The **Start** button is only present on SendPro C models equipped with an automatic feeder.
7. Tap **Tape** to begin printing postage on tape. To print more than one tape, tap the number next to **Tape** and enter the number of tapes. **Tape** is only present on SendPro C models equipped with an automatic feeder.
8. Tap **Class** to view the class and any extra services.
9. Tap **Print Mode** to access the Print Mode screen. This provides you with different printing modes such as adding graphics to your envelope, adding more postage, or making corrections to the date. You can also choose to seal envelopes without printing postage.

Checking the available funds for printing postage

Check your funds for printing postage on your device at any time.

Viewing the amount available in your device

1. Tap **Print on Envelopes** on the Home screen.
2. The **Postage Balance** shows the available funds in your device.

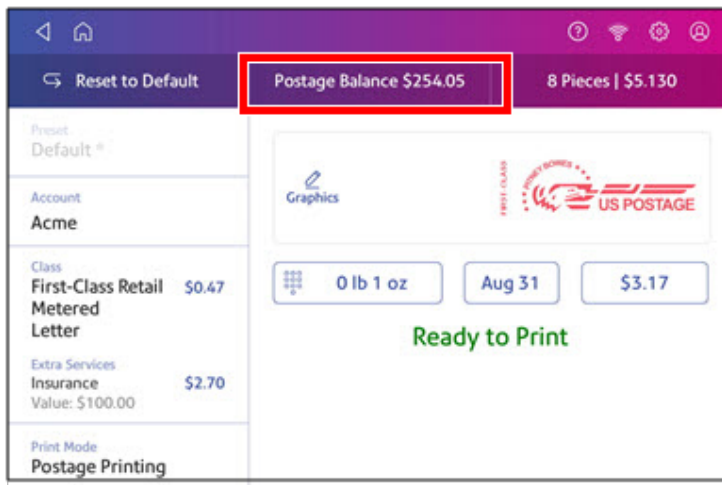

Viewing the amount available in your postage account at Pitney Bowes

1. Tap **Print on Envelopes** on the Home screen.
2. Tap **Postage Balance**.

3. Tap **Settings**.
4. The balance in your postage account appears.

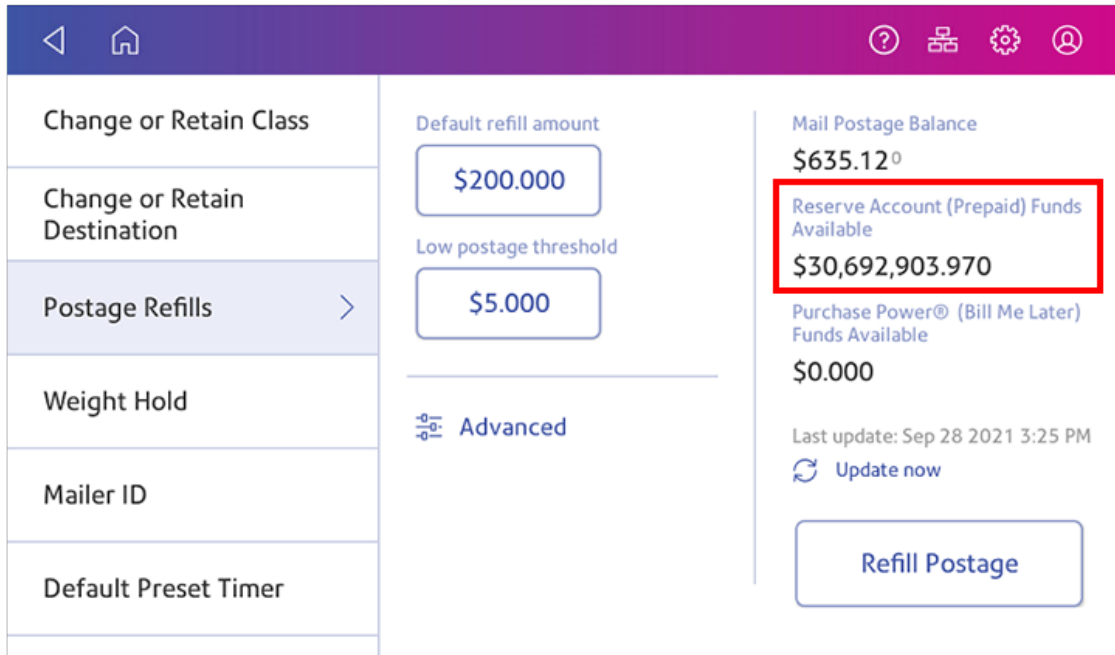

Adding or refilling postage for printing on envelopes

Add or refill postage for your Print on Envelopes balance as soon as you receive a message that your funds are getting low.

Before you begin

Check that your device is connecting to the internet.

- For wired network connections, the following connection image appears in the toolbar:



- If you have a wireless connection, the following connection image appears in the toolbar:



Add postage for Printing on Envelopes

1. Tap **Print on Envelopes** on the Home screen.
2. Tap **Postage Balance**.
3. Tap **Refill Postage**.
4. Enter the amount of postage you wish to add.
5. Tap **Refill Mail Postage**.
6. Tap **View Receipt** to view or print a receipt.
7. Tap **Done**.
8. Your updated postage balance appears on the Print on Envelopes app.

Sending a First-Class Mail envelope

First-Class Mail is an economical way to send mailpieces through the USPS. You can send standard postcards, letters, and large envelopes and small packages up to 15.99 ounces.

1. Tap **Print on Envelopes** on the Home screen.
2. If you have the accounting feature enabled, tap **Account** and select an account.
3. Tap **Class**.
4. Tap **Start Over** to show a list of all the available classes.
5. Tap **First-Class Retail Metered** for a First-Class Mail envelope.
6. Tap **Letter**.
7. Select any special services you wish to use.
8. Tap **Apply**.
9. Place the envelope on the scale. The weight appears.

10. Place the envelope or envelopes on the feed deck. Depending on the SendPro C model you have, feed the envelopes manually or tap **Start** to feed the envelopes.

Important: Your device will upload transactions if you have previously printed any mail. Once the upload completes, you see the message "Transaction upload status, Upload success" with a check mark. Tap the check mark.

Sending a large First-Class® envelope

Before you select a rate for a large envelope, you need to determine whether the mailpiece you are sending is a letter or large envelope according to the USPS.

If your mailpiece weighs more than 3.5 oz, the device automatically sets the class to Large Envelope regardless of the dimensions. If the mailpiece weighs less than 3.5 oz but has the dimensions of a large envelope, you need to manually select Large Envelope when you choose the class.

Weigh the mailpiece and measure the dimensions

1. Tap **Print on Envelopes** on the Home screen.
2. If you have the accounting feature enabled, tap **Account** and select an account.
3. Place the mailpiece on the scale. The weight appears. You can also weigh the mailpiece using any other postal scale.

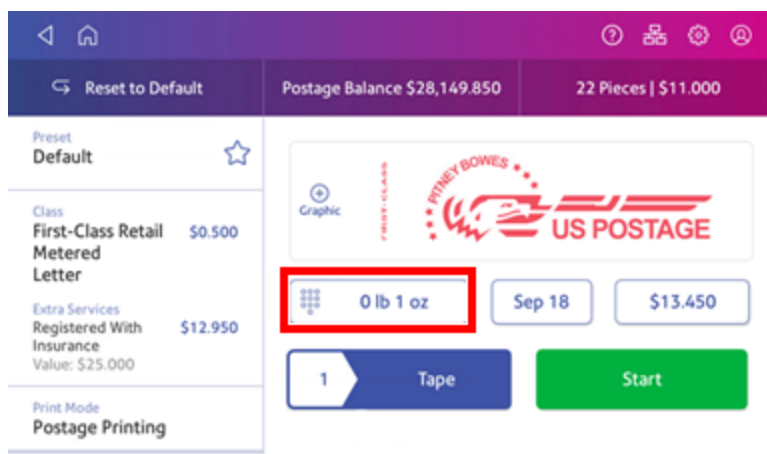

4. Measure and record the dimensions of the mailpiece.
5. Tap **Home** to return to the Home screen.

If the mailpiece is less than 3.5 oz, but has the dimensions of a large envelope:

1. Tap **Home**.
2. Tap **Print on Envelopes**.
3. If you have the accounting feature enabled, tap **Account** and select an account.
4. Tap **Class**.
5. Tap **Start Over** to show a list of all the available classes.
6. Tap **First-Class Retail Metered** for a First-Class mail envelope.
7. Tap **Large Envelope**.
8. Select special services, if required.
9. Tap **Apply**.
10. Place the envelope or envelopes on the feed deck. Depending on the SendPro C model you have, feed the envelopes manually or tap **Start** to feed the envelopes.
If the envelope is too thick to go through the feeder, print the postage on a tape and apply the tape to the large envelope or flat.

Sending Certified Mail

Certified Mail is a USPS service that provides you with proof of mailing by sending you a receipt once your mailpiece arrives at its destination.

Not all extra services like Certified Mail are available for all classes and you can only combine certain services.

1. Tap **Print on Envelopes** on the Home screen.
2. If you have the accounting feature enabled, tap **Account** and select an account.
3. Tap **Class**.
4. Tap **Start Over** to show a list of the available classes.
5. Tap a class that you can combine with Certified Mail (for example, First Class or Priority Mail).
6. Tap the mailpiece type (for example, letter or large envelope).
7. Select **Certified** and tap **Apply**.
8. Depending on the type class and type of mailpiece, enter the destination ZIP Code and tap **Apply**.
9. Place the envelope or envelopes on the feed deck. Depending on the SendPro C model you

have, feed the envelopes manually or tap **Start** to feed the envelopes.

10. Place the green Certified Mail label (USPS Label 3800) on the mailpiece.

Sending an international letter

Use this process if you need to send mail from the United States to a different country.

1. Tap **Print on Envelopes** on the Home screen.
2. If you have the accounting feature enabled, tap **Account** and select an account.
3. Tap **Class**.
4. Tap **Start Over** to display a list of all the available classes.
5. Tap **First-Class Mail Intl Retail** for a First-Class Mail envelope.
6. Tap **Letter**.
7. Tap in the **Country** field and use the keypad to enter the destination country.
8. Select special services, if required.
9. Tap **Apply**.
10. Place the envelope on the scale. The weight appears.
11. Place the envelope or envelopes on the feed deck. Depending on the SendPro C model you have, feed the envelopes manually or tap **Start** to feed the envelopes.

Important: Your device will upload transactions if you have previously printed any mail. Once the upload completes, you see the message "Transaction upload status, Upload success" with a check mark. Tap the check mark.

Sending mail using a Certificate of Mailing

Purchase a Certificate of Mailing when you need to have proof that you sent a letter or package.

You can only obtain a Certificate of Mailing from the USPS. A Certificate of Mailing is a receipt that provides evidence of the date that you took your mail to the USPS for mailing. You cannot produce this certificate with your device. It is a record of when you turned the mailpiece over to the Post Office and you can only get it from the USPS.

1. Fill out the USPS postal forms [3606-D](#), [3665](#), or [3817](#). Obtain these at the Post Office or online at the [USPS website](#).
2. Calculate the fees for all of the mailpieces. This can include the cost of the Certificate of Mailing fees as well as the total postage amount.

3. Tap **Print on Envelopes** on the Home screen.
4. If you have the accounting feature enabled, tap **Account** and select an account. If your device's model number is 8H00 or 9H00 and if you have only a single account, once you select that account the device will remember that account the next time you start Print on Envelopes.
5. Scroll down and tap **Print Mode** on the Print on Envelopes screen.
6. Tap **Certificate of Mailing**.

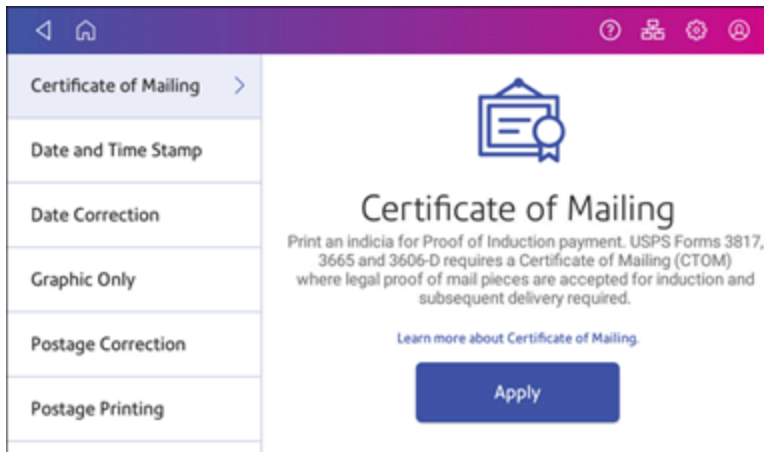

7. Tap **Apply**.

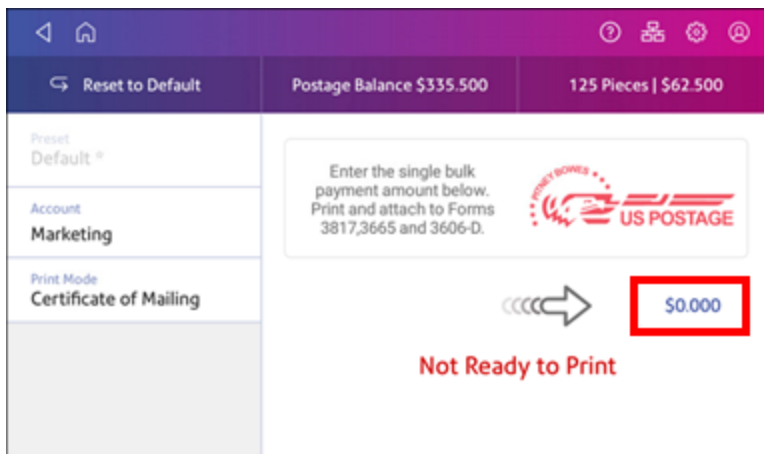

8. Tap on the postage amount and enter the amount you calculated in step 2.
9. Feed the appropriate form (3606-D, 3665, or 3817) through the feeder so that the device stamp prints on the form or on a tape strip that can be applied to the form. Alternatively, you can print the device stamp on each of the mailpieces included in the Certificate of Mailing.
10. Take the mailpieces and the printed form to the Post Office. They will apply a round stamp proof of induction mark that serves as legal proof that your items will enter the USPS.

Advancing the date

Watch this video or follow the instructions below to learn how to advance the date.

Advance the date to print postage up to thirty days before you need to send it.

1. Tap **Print on Envelopes** on the Home screen.
2. Tap the date. The calendar appears.
3. Tap **Tomorrow** or **Another Date**, depending on the date you wish to print.
4. When you see the future date highlighted on the calendar, tap **Apply**.
5. Place the envelope or envelopes on the feed deck. Depending on the SendPro C model you have, feed the envelopes manually or tap **Start** to feed the envelopes.

Important: The date on the postage should match the date when your mail goes to the post office. Your device automatically advances the printed date on the device stamp (as well as its internally held date) when the device time reaches 5:00 PM. You cannot change this time.

Printing postage without a date for pre-printed mailpieces

If you wish to use a pre-printed return envelope, card, or label on which the postage is prepaid, you must print the postage without a date.

This feature is only available for Meter Reply Mail with First-Class Retail Metered classes that include Letter, Non-Machinable Letter, Large Envelope, and Postcard.

1. Tap **Print on Envelopes** on the Home screen.
2. Tap **First-Class Retail Metered Letter**.

3. On the Class & Extra Services screen, scroll down and tap the **Restricted Use Return Mail** box.

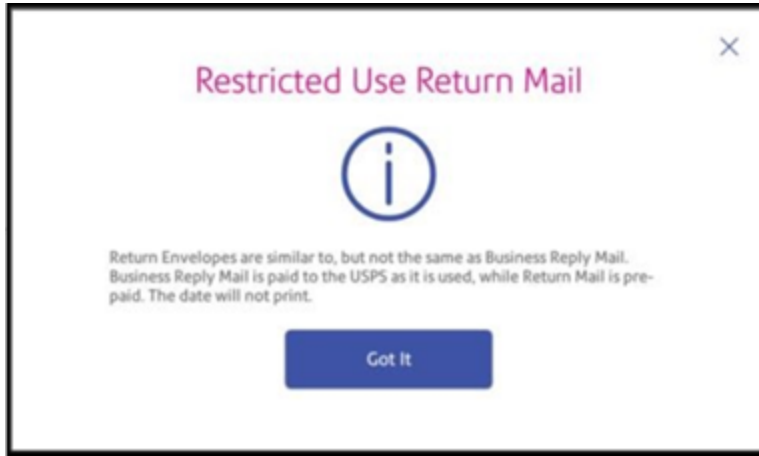

4. A message informs you that no date will print. Tap **Got it**.
5. Tap **Apply**.
6. **Restricted Use Return Mail** appears in the Extra Services box on the Print on Envelopes screen.

Printing additional postage

If you do not have enough postage on an envelope, you can add more postage directly on a blank area on your envelope or you can print the additional postage on a tape.

1. Tap **Print on Envelopes** on the Home screen.
2. Scroll down and tap **Print Mode**.
3. Tap **Postage Correction**.
4. Tap **Apply**.

5. Tap the postage amount.

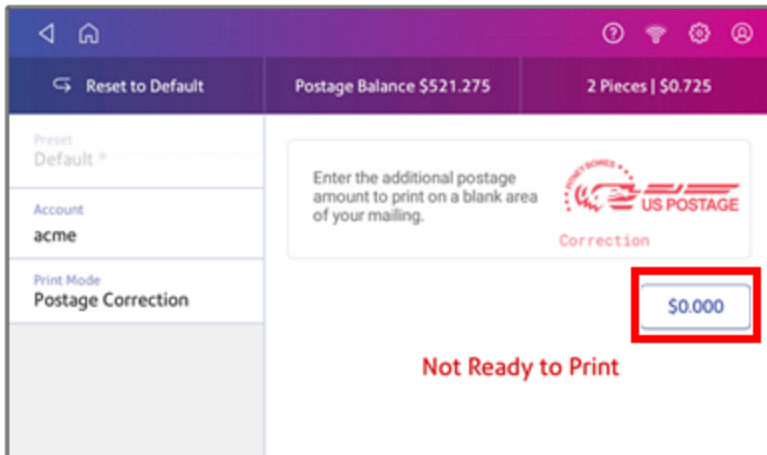

6. Use the keypad to enter the additional postage amount.
 7. Tap the check mark when done.
 8. Turn your envelope over to the blank side.
 9. Place the envelope or envelopes on the feed deck. Depending on the SendPro C model you have, feed the envelopes manually or tap **Start** to feed the envelopes.
- The word "Correction" appears on the postage mark:



Re-dating your mail

Watch this video or follow the instructions below to learn how to redate your mail.

If you already printed today's date and postage on an envelope, but you missed your mail pickup, you can re-date the mail. You must print a future date on the back of the envelope before you can mail it. You can only re-date one envelope at a time, even if you are feeding envelopes automatically.

1. Tap **Print on Envelopes** on the Home screen.
2. Scroll down and tap **Print Mode**.
3. Tap **Date Correction**.
4. Tap **Apply**.
5. Tap on the date.
6. Tap **Tomorrow** or **Another Date**, depending on the date you need.
7. Tap **Apply** after you select the new date.
8. Turn the envelope over to the blank side.
9. Place the envelope on the feed deck. Depending on the SendPro C model you have, feed the envelope manually or tap **Start** to feed the envelope. The word “Redate” appears on the newly printed print on the back of the envelope.

Using USPS special services

You can select additional services for your mail. These include Certified Mail, Insured Mail, Delivery Confirmation, Registered Mail and more. The number and types of services available depend on the class of mail.

1. Tap **Print on Envelopes** on the Home screen.
2. Tap **Class**.
3. Tap **Start Over** to see a list of the available classes.
4. Tap the class you wish to use. Sub-classes appear when available for the selected class.
 - For some classes, you must select the type of mailpiece. For example, if you select First-Class Retail Metered, you must select either Letter, Large Envelope, or Package.
5. Select any special services you wish to use.
6. Enter a ZIP code if required.
7. For some classes, you need to either scan or manually enter the Electronic Certified barcode from your label. Then, attach your label to your envelope or package.
8. Tap **Apply**.

Entering the weight manually when printing postage

Enter the weight of a mailpiece when you know its weight and are not using the scale.

1. Tap **Print on Envelopes** on the Home screen.
2. Tap **Weight**.

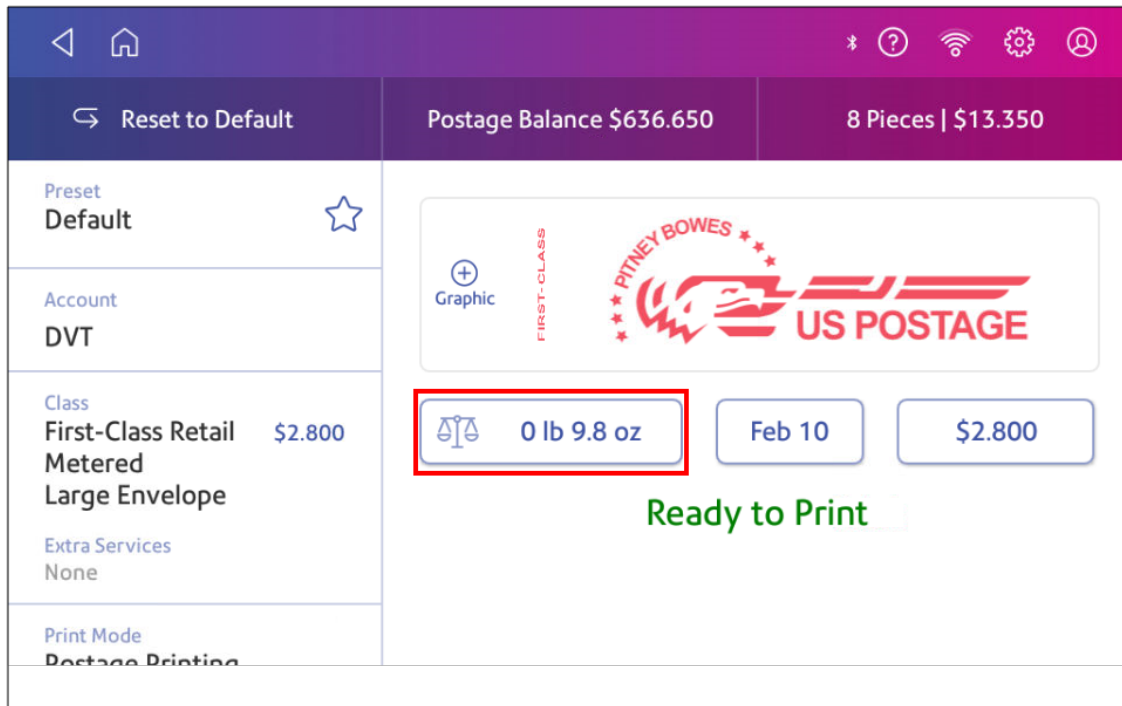

3. Tap **Manual**.
4. Enter the **pounds** and **ounces**.
5. Tap **Apply**.
6. Tap **Class**.
7. Tap **Start Over** to see all the class options.
8. Select the class and any special services required.
9. Tap **Apply**.
10. Place the envelope or envelopes on the feed deck. Depending on the SendPro C model you have, feed the envelopes manually or tap **Start** to feed the envelopes.

Using the scale when printing postage

Use the scale to weigh your mail and calculate the correct postage for you.

1. Tap **Print on Envelopes** on the Home screen.
2. Tap **Weight**.

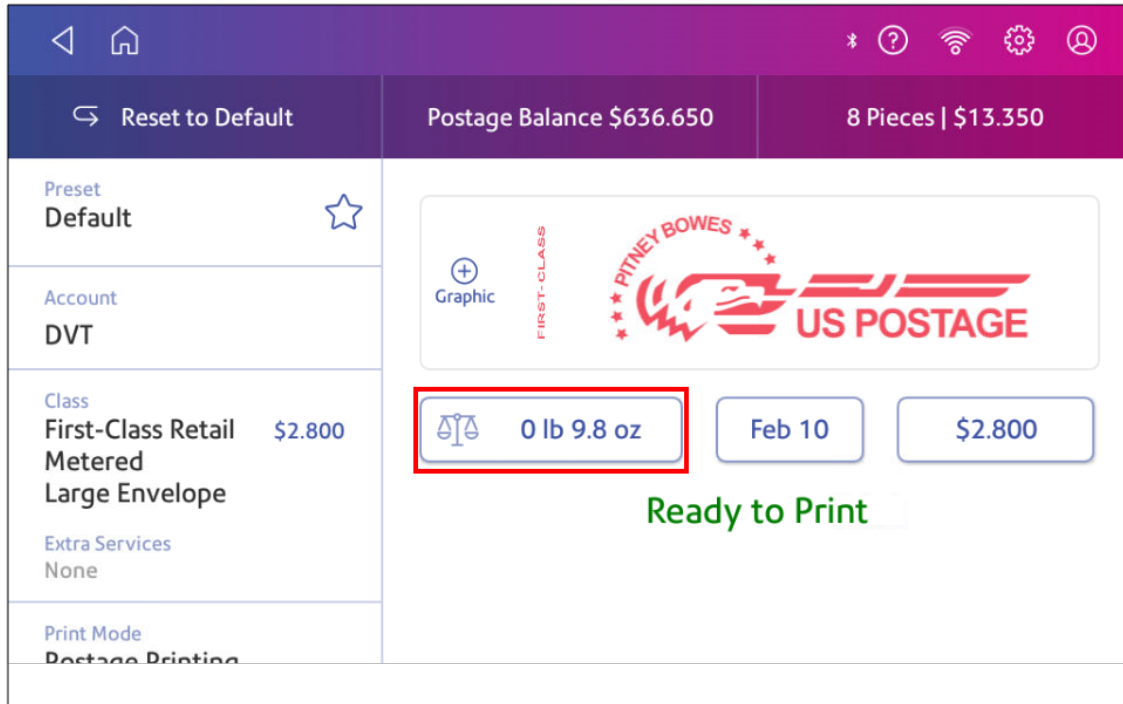

3. Tap **Scale**.
4. Place the envelope on the scale. You must do this before the next step or else the **Apply** button remains inactive.
5. Tap **Apply**.
6. Tap **Class**.
7. Select **Start Over** to show the class options.
8. Tap the class you want.
9. Select special services, if required.
10. Tap **Apply**.
11. Place the envelope or envelopes on the feed deck. Depending on the SendPro C model you have, feed the envelopes manually or tap **Start** to feed the envelopes.
12. The scale retains the weight of the mail for approximately 70 seconds. Add another mailpiece to the scale if you want to override the weight.

Sealing envelopes without printing postage

Use Seal Only mode to seal envelopes without printing anything.

Printing on envelopes

1. Tap **Print on Envelopes** on the Home screen.
2. Tap **Print Mode**. You may need to swipe up on the screen to see this option.
3. Select **Seal Only**.
4. Tap **Apply**.
5. Place your envelope face up, flap down into the feeder. Be sure to slide the envelope flap under the edge of the feed deck.



6. Insert the envelope into the device. The device seals the envelope.



Sealing envelopes when you print postage

You can seal envelopes and print postage at the same time with your SendPro C Lite, SendPro C, SendPro+.

1. Check the level of sealing solution in the moistener tank. Add more if required.
2. Slide the envelope flap under the edge of the feed deck so the moistener can wet the flap.



3. Tap **Print on Envelopes** on the Home screen.
4. Tap **Account** and select an account if accounting is enabled on your device.

5. Tap **Weight**.

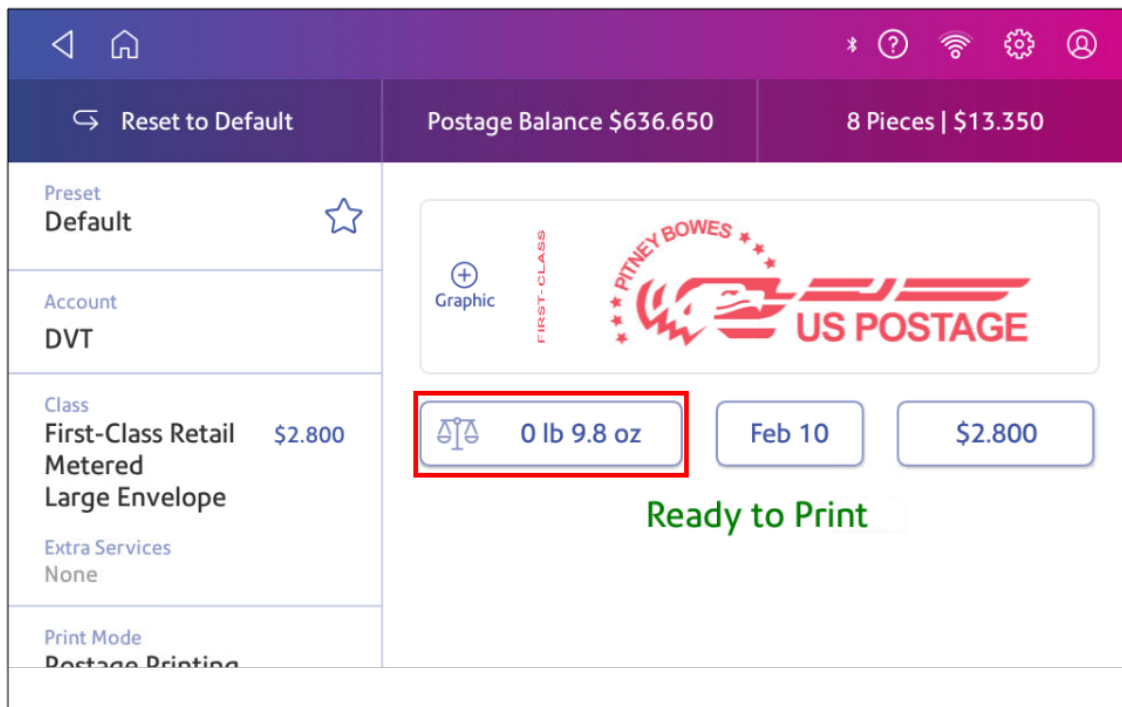

6. Tap **Scale**.

7. Place the envelope on the scale. You must do this before the next step or else **Apply** remains inactive.

8. Tap **Class** then select the class of mail you want.

9. Tap **Graphic** then select a graphic, if necessary.

10. Tap **Apply** to continue.

11. Insert the envelope into the device. The device prints the postage .

Important: If the moistener tank is full and your envelopes do not seal correctly, clean or replace the moistener brush and wick.

Zeroing the scale

Zero the scale to set the weight to zero.

Make sure there is nothing on the scale when you zero it.

1. Tap **Print on Envelopes** on the Home screen.
2. Tap **Weight**.

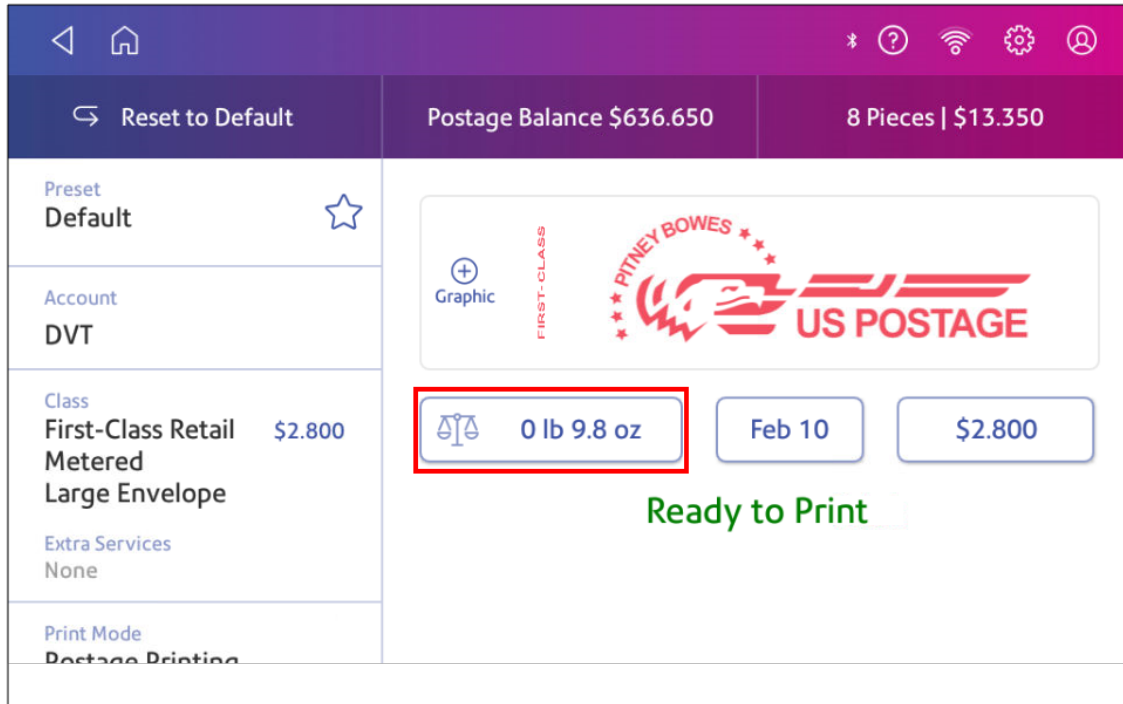

3. Tap **Scale** on the weighing method screen.
4. Tap **Zero Scale**.
5. Tap **Cancel** to return to the Print on Envelopes app.

Adding insurance to your mail

You can purchase insurance for your mailpiece to protect against loss, damage or missing contents. The insurance covers only the actual value of the mailed contents.

1. Tap **Print on Envelopes** on the Home screen.
2. Tap **Class**. If this is the class you need, tap the **Insurance** box, enter the amount, and tap **Apply**. If you need another class, go to step 3.
3. If you need a different class:
 - a. Tap **Start Over** and select a new class and any special services you need. Tap **Apply** after adding special services.
 - b. Tap the **Insurance** box, enter the amount, and tap **Apply**.

4. To confirm, tap **Apply**.
5. Place the envelope or envelopes on the feed deck. Depending on the SendPro C model you have, feed the envelopes manually or tap **Start** to feed the envelopes.

Adding a graphic to your envelope or tape

Your device comes with a set of standard graphic images that you can add to your envelopes or tapes when you print your postage. Graphic ads are also known as ads, slogans or logos. Examples include PLEASE OPEN IMMEDIATELY, RECYCLE, and Season's Greetings.

1. Tap **Print on Envelopes** on the Home screen.
2. Weigh your envelope, select a class, and select any special services required.
3. Tap the **Graphics** icon on the Envelope Printing screen.
4. Select the graphic you wish to use.
5. Tap **Apply**.
6. Place the envelope or envelopes on the feed deck. Depending on the SendPro C model you have, feed the envelopes manually or tap **Start** to feed the envelopes.

To remove a graphic:

1. Tap the current graphic to deselect it.
2. Tap **Apply**.

Sending mail using Electronic Return Receipt (ERR)

Tracking services are available when you use the scale or Manual Weight entry method. The following steps are based on using Priority class and the Electronic Certified service with Electronic Return Receipt (ERR).

In order to use ERR, you must submit Form 5053, Bulk Proof of Delivery to the USPS. The USPS then provide you with a 9-digit USPS Mailer ID. You need to enter this number when using ERR. The following procedure is an example of how to use ERR.

1. Tap **Print on Envelopes** on the Home screen.
2. Place the envelope or package on the scale.
3. Tap **Class**. If **Priority Mail Retail** is not the current class, tap **Start Over**, then select **Priority Mail Retail** from the list of classes.

4. Tap **Envelope or Package**.
5. Enter the ZIP Code, then tap **Apply**.
6. Tap the **Electronic Certified** box.
7. Tap the **Electronic Return Receipt** box.
8. Tap **Apply**.
9. Enter the barcode number from your USPS PS Form 3800 using the keypad or use the optional barcode scanner. The barcode number should start with a 94.
10. (Optional) Add your Customer Reference Number. Tap **Apply** to confirm.
11. When prompted to apply the barcode label on the envelope, tap **Continue**. The barcode appears in the Class section of the screen.
12. Place the envelope or envelopes on the feed deck. Depending on the SendPro C model you have, feed the envelopes manually or tap **Start** to feed the envelopes.

Getting a USPS refund for damaged or incorrectly printed mail

Once you print an impression, your device deducts the postage amount from the postage funds. This happens even if the printing is illegible. Therefore, it is important to:

- Ensure that the correct value appears before printing postage.
- Ensure that the ink level does not get too low. **Recommended:** Always have a spare ink cartridge available.

For up-to-date refund guidelines, refer to the FAQ page of the USPS website.

Postage device indicia is eligible for a refund if it is complete, legible, valid, unused and printed on un-mailed envelopes, wrappers, or labels made in accordance with USPS DMM 604.9.3.4. This includes:

- Postage printed on the back (versus the front) of a letter
- Only a portion of the postage printed, or postage is not legible
- Too much postage was printed on the item
- Not enough postage was printed on the item
- Incorrect date on the device
- Incorrect information (street name, street number, city, etc.)

Your refund request must include:

Printing on envelopes

- a completed USPS Form 3533
- proof that the person requesting a refund is an authorized user of the device
- unused meter indicia

You must submit your refund request within 60 days from the date shown on the mail to your local Post Office.

For all indicia except those produced by PC Postage systems, you must submit the indicia to the licensing Post Office.

- The Postal Service™ refunds 90% of the face value on the indicia if the total is \$500 or less.
- If the total face value is more than \$500, the charge is \$50 per hour for the actual hours to process the refund, with a minimum charge of \$50.

Creating a custom text message for your mail

You can create a custom text message for your mailpiece. The message can be up to 5 lines with each line containing a maximum of 20 characters. You can leave any of the 5 lines blank. The message is centered on the envelope or tape when you print postage.

1. Tap **Print on Envelopes** on the Home screen.
2. Tap **Print Mode**.
3. Tap **Graphic Only**.
4. Tap **Apply**.
5. Tap **+ Graphic**.

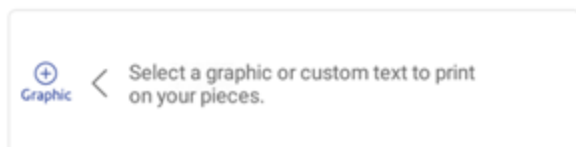

6. Tap **Custom Text**.

7. Tap **+ Add**.

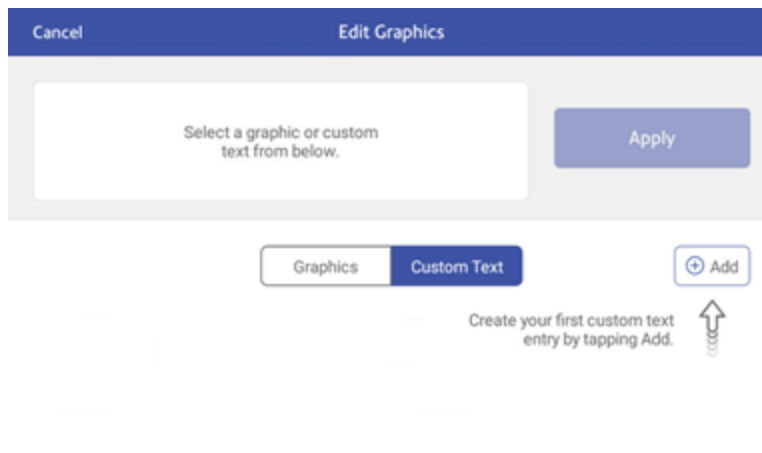

8. When creating a message, a message appears to inform you that you must comply with Postal rules. Tap **Accept & Continue** to agree.
9. Enter a name for the text message, then tap **Save**

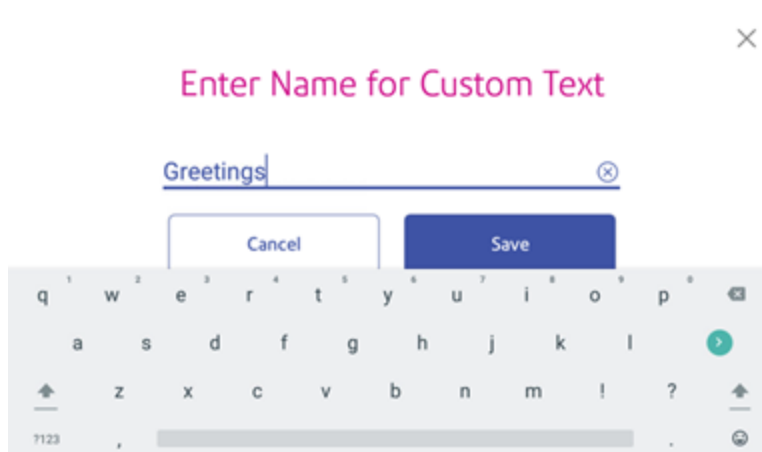

10. Enter the text on any or all the lines, with a maximum of 20 characters per line.

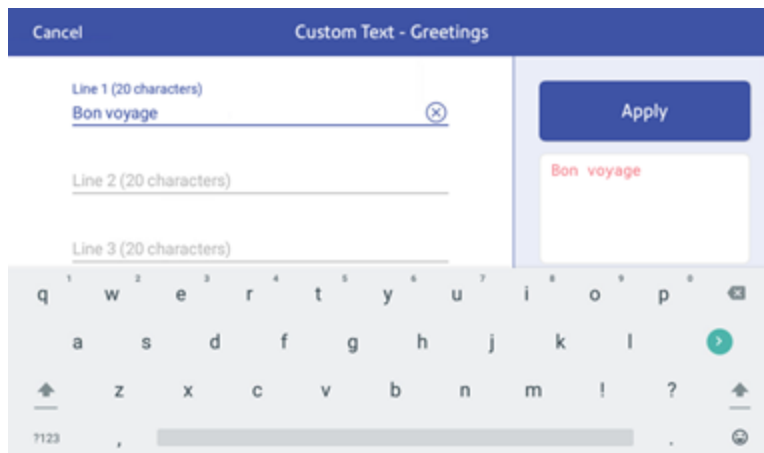

11. When finished, tap **Apply**. The screen displays the message as it will appear on your envelope or tape.
12. Tap **Apply** again. The custom text message is now available when you print postage.
13. Tap the back arrow to return to the Home screen.

Adding a custom text message to your envelope or tape

Your SendPro C Lite, SendPro C, SendPro+ allows you to add a custom text message to your mail. This can be a return address, for example. Your message can be up to five lines, with 20 characters per line. The message prints on the left side of the print.

1. Tap **Print on Envelopes** on the Home screen.
2. Weigh your envelope, select a class and special services, if required.

3. Tap + Graphics.

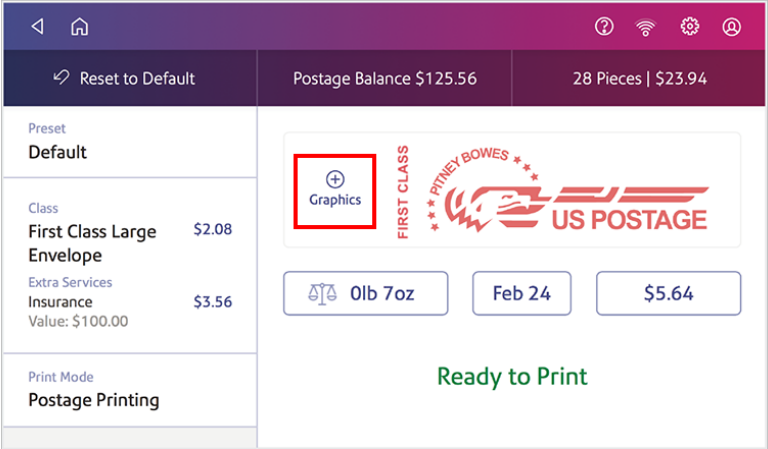

4. Tap Custom Text.



5. Tap on the text message you wish to use. A green check mark appears next to the selected message.



6. Tap **Apply**. The custom text message appears on a preview screen.

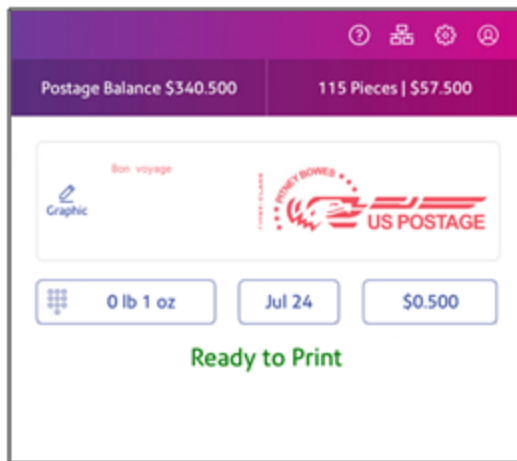

7. Feed the envelope or tape strip through the device.

Editing or deleting a custom text message

Your device allows you to add a custom text message to your mail. You can edit or delete messages you no longer need.

- 1. Tap **Print on Envelopes** on the Home screen.
- 2. Tap **+ Graphics** on the Print on Envelopes screen.

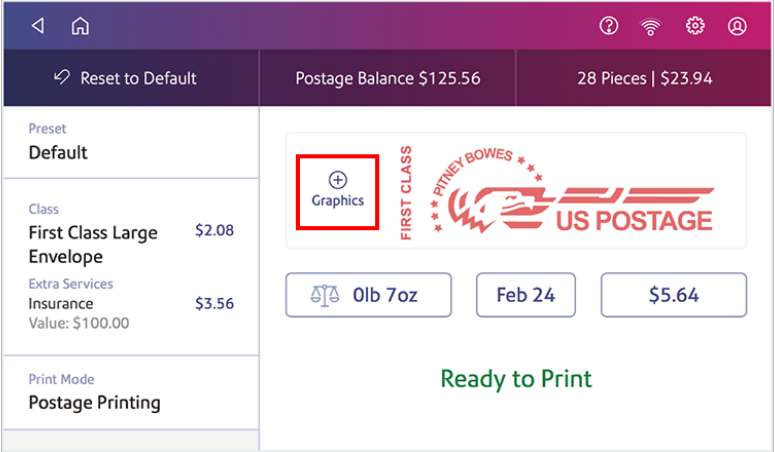

- 3. Tap **Custom Text**.

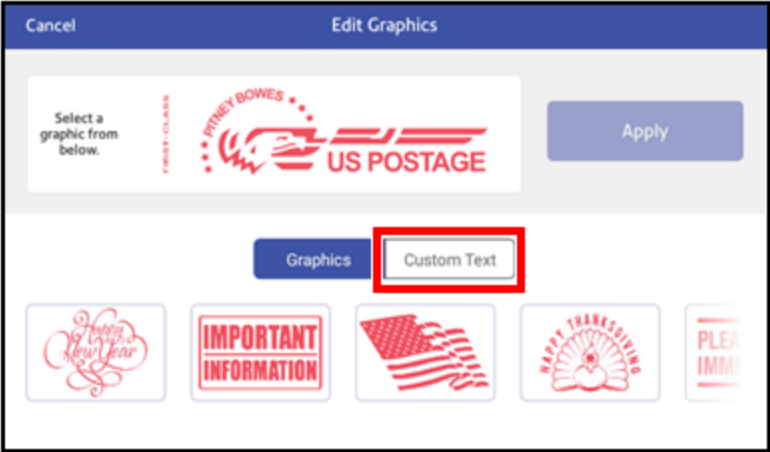

4. Tap on the custom message you wish to edit or delete, then tap **Edit**.



5. Select the appropriate option. You can edit the text message, rename it, or delete it.

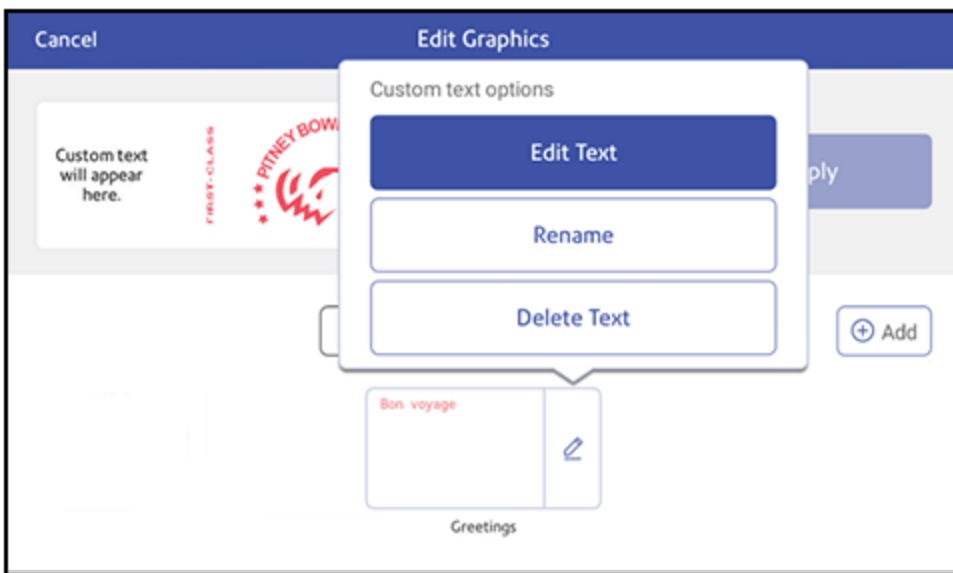

6. Tap **Apply**.

Printing a graphic without printing postage

Print a graphic without printing postage, such as the Received graphic on incoming mail.

1. Tap **Print on Envelopes** on the Home screen.
2. Tap **Print Mode**.
3. Select **Graphic Only**.
4. Tap **Apply**.
5. Tap **Graphic**.
6. Tap **Graphics**, then select your graphic.
7. Confirm with **Apply**.
8. Print the graphic on the envelope or tape.

Adding an inscription

Inscriptions appear automatically when you select certain classes of mail. This saves you time and helps you always use the correct inscription.

For example, if you select First Class mail, the First Class inscription prints automatically on your mail.

Printing only the date and time

Print the date and time to keep a record of when you receive incoming mail.

Printing on envelopes

1. Tap **Print on Envelopes** on the Home screen.
2. Tap **Print Mode** (you may have to scroll down to see this).

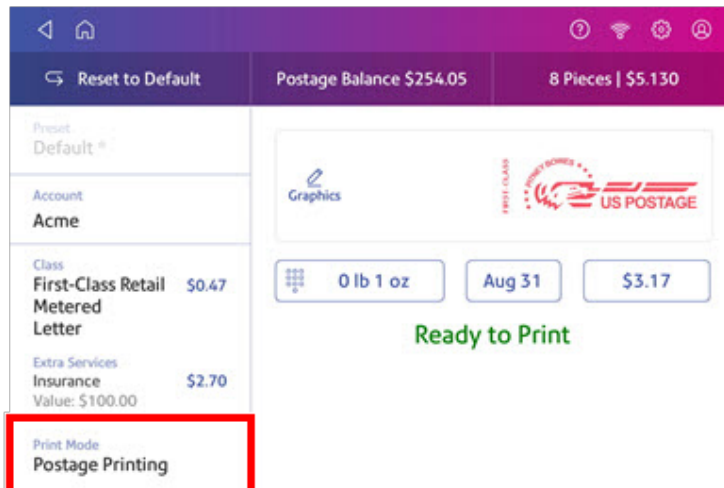

3. Select **Date and Time Stamp**.
4. Tap **Apply**.
5. Place the envelope or envelopes on the feed deck. Depending on the SendPro C model you have, feed the envelopes manually or tap **Start** to feed the envelopes.

7 - Managing Printing on Envelopes

In this section

Confirming your meter update.....	149
Changing the default refill amount for printing postage.....	149
Uploading postage transactions.....	150
Clearing or resetting the number of mailpieces sent ...	151
Performing USPS postal inspections for postage printing.....	151
Updating postal rates or software for printing on envelopes.....	151
Confirm the effective date for postal rates.....	152
Setting the low funds warning for printing postage.....	153
Setting up a mailer ID.....	153
Updating the ZIP code.....	154
What is Accounting.....	154
Turning Print on Envelopes account passwords on or off for printing postage.....	155
Adding a Print on Envelopes account.....	157
Editing an account.....	157
Making an account inactive.....	158
Deleting an account.....	158
Creating presets for printing postage.....	159
Viewing presets for printing postage.....	160
Selecting a preset for printing postage.....	160
Modifying presets for printing postage.....	160
Setting the default preset timer.....	161

Confirming your meter update

To check if you have the latest rates for Print on Envelopes:

1. Locate your Product Code Number (PCN) and 7-digit serial number.
2. Go to the [Confirm your meter update](#) web page.
3. Select your PCN from the menu and enter the serial number in the field provided.
4. Click **Confirm Meter Update**.

Changing the default refill amount for printing postage

Change the default refill amount to store an amount you want to refill your device with.

You can set the default refill amount during installation or change it at later time.

There are two ways to change the default refill amount:

From the Home Screen:

1. Tap **Settings**.



2. Scroll down to the Envelope Printer Settings section.
3. Tap **Postage Refills**.
4. Tap the box under **Default refill amount**.
5. Tap the back key to remove the existing amount. You may need to tap the key multiple times to clear the amount.
6. Enter the new amount.
7. Tap **Apply**.
8. Tap the back arrow to return to the Home screen.

From Print on Envelopes:

1. Tap **Print on Envelopes** from the Home screen.
2. Tap **Postage Balance**.
3. Tap **Refill Settings**.
4. Tap the box under **Default refill amount**.

5. Tap the back key to remove the existing amount. You may need to tap the key multiple times to clear the amount.
6. Enter the new amount.
7. Tap **Apply**.
8. If necessary, tap the back arrow to return to the Print on Envelopes app.

Uploading postage transactions

Automatic upload of your postage transactions

- Your device automatically uploads your postage transactions to the Pitney Bowes Data Center. This occurs at least once during the day and once after hours.
- If you lock your device or turn it off for any extended period, it automatically uploads your transactions when you turn it on again.
- If you see the message "Sync Transaction Data" or "Sync USPS Transaction Data", it means you need to upload your transactions.

Important: If your device had connection issues recently, it may require multiple uploads to upload transactions. If the device prompts you to upload more than three times, please contact technical support.

Manual upload of your postage transactions

1. Tap **Settings**.



2. Scroll down to the Envelope Printer Settings section.
3. Tap **Sync Transaction Data** or **Sync USPS Transaction Data**.
 - A series of messages appear, starting with "Preparing Transaction Data" followed by "Sending Transaction Data."
 - Once the upload is complete, the message "Transaction Data Sent" appears.
 - The message "No Sync Required" appears if there are no new transactions to upload.

Clearing or resetting the number of mailpieces sent

Reset the piece counter to delete the piece count information.

Make certain that you wish to delete the piece count information. Once you do so, you cannot restore the deleted data.

1. Tap **Print on Envelopes** on the Home screen.
2. Tap **Pieces**.
3. Tap **Reset Counter to 0**.

Performing USPS postal inspections for postage printing

Perform a balance inquiry or postage refill when the Inspection Due message appears.

When a postal inspection is required, you are notified automatically by the "Inspection Due. Perform a balance inquiry or a refill" message on the Print on Envelopes app.

1. If accounting is enabled, you must first tap **Account** and select an account.
2. Tap **Balance Inquiry** or **Refill Postage** to complete the inspection.

Updating postal rates or software for printing on envelopes

Automatic updates

Your device updates postal rates and software automatically.

Keep your device turned on and connected to your network to get your automatic updates, as the device downloads updates during the evening hours.

Manual postal rate updates

1. Select Rates and Updates:
 - Tap **SendPro Apps**, then **Rates and Updates**.

2. If new rates are available, your device downloads and installs updates.
 - a. If the rates are available today, this message appears:
"New postage rates took effect today. Your device has been updated and new rates are already in effect. To learn more, visit pitneybowes.com/ratesandupdates."
 - b. If the rates took effect already, this message appears:
"New postage rates took effect on [effective date]. Your device has been updated and new rates are already in effect. To learn more, visit pitneybowes.com/ratesandupdates."
 - c. If the new rates are pending, this message appears:
"New postage rates take effect on [future effective date]. Your device has been updated and you'll see the new rates then. To learn more, visit pitneybowes.com/ratesandupdates."
3. To continue tap **Got it**.

Manual software updates

1. Select Rates and Updates:
 - Tap **SendPro Apps**, then **Rates and Updates**.
2. If new rates are available, your device downloads and installs updates.
 - a. If the rates are available today, this message appears:
"New postage rates took effect today. Your device has been updated and new rates are already in effect. To learn more, visit pitneybowes.com/ratesandupdates."
 - b. If the rates took effect already, this message appears:
"New postage rates took effect on [effective date]. Your device has been updated and new rates are already in effect. To learn more, visit pitneybowes.com/ratesandupdates."
 - c. If the new rates are pending, this message appears:
"New postage rates take effect on [future effective date]. Your device has been updated and you'll see the new rates then. To learn more, visit pitneybowes.com/ratesandupdates."
3. To continue tap **Got it**.

Confirm the effective date for postal rates

You can check to see if you have downloaded the latest rates for each postal class on your device.

1. Tap **Print on Envelopes**.
2. Tap **Class**.
3. Tap **Start Over** to display a list of all the available classes.

4. Tap the information icon (i) next to the class you wish to check, for example First-Class Retail Metered. The rate change information appears for the class.

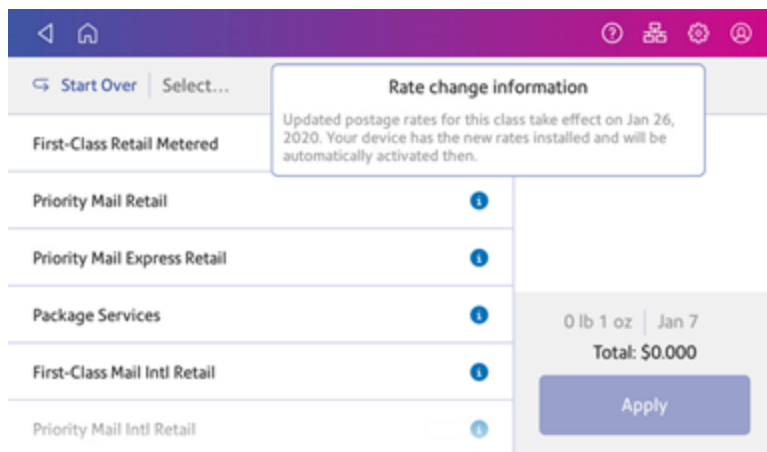

Setting the low funds warning for printing postage

Set the low funds warning to warn you when your available funds for printing postage reaches a certain amount. Use this warning as a reminder to add more postage to your device.

1. Tap **Print on Envelopes** on the Home screen.
2. Tap **Postage Balance**.
3. Tap **Refill Settings**.
4. Tap **Low postage threshold**.
5. Tap **back** on the keypad to remove the existing amount.
6. Enter the new amount.
7. Tap **Apply**.
8. If necessary, tap the back arrow to return to the Print on Envelopes app.

Setting up a mailer ID

Your mailer ID is a 9-digit number that you need when using Electronic Return Receipt (ERR). To get your mailer ID, submit Form 5053, Bulk Proof of Delivery to the USPS.

1. Tap **Settings**.



2. Scroll down to the Envelope Printer Settings section.
3. Tap **Postage Refills**.
4. Tap **Mailer ID**.
5. Enter the 9-digit number using the keypad.
6. Tap **Apply**.

Updating the ZIP code

The ZIP code printed by your device should be either your ZIP code or the ZIP code of the post office picking up your mail.

If your device prints an incorrect ZIP code, a Pitney Bowes representative must resolve this issue. Contact technical support for assistance.

What is Accounting

You can use the accounting feature to track the postage that departments or individuals within your organization use.

The accounting feature helps you to understand how your business spends its postage and identify cost-saving opportunities. You can charge postage back to departments or clients and report on postage expenditures.

The Print on Envelopes app uses a multi-level account format. It is different from the Create Shipping Labels Cost Accounts.

When you use Print on Envelopes accounts to track your postage usage, use sub accounts and sub sub accounts to analyze your usage within an account.

How you create accounts depends on your needs. You can create accounts in single or multiple levels. For example, you can divide a top level department (account) into two additional sub sections (sub accounts and sub sub accounts).

The Print on Envelopes accounting structure can have up to a three level hierarchy:

- account (top level of the hierarchy)
- sub account (next possible level of the hierarchy)
- sub sub account (last possible level of the hierarchy)

Important: Only the lowest level of the account hierarchy is chargeable. This means that the lowest level of the account has the transactions applied to them.

- **Account with no sub accounts** - When you create an account with no sub accounts, you charge postage to that account. This is because the account does not have sub or sub sub accounts.
- **Account with sub account or sub sub account** - When you create a sub account or sub sub account, you charge postage to the lowest level (the sub account or sub sub account).

Account hierarchy examples

Top level account

- Engineering

Account with sub accounts

- Engineering; Sub account - Software;
- Engineering; Sub account - Hardware;

Account with sub sub accounts

- Engineering; Sub account - Software; Sub sub account - Graphics and Layout; Sub sub account - Design
- Engineering; Sub account - Hardware; Sub sub account - Quality Approval; Sub sub account - Testing

Turning Print on Envelopes account passwords on or off for printing postage

You can protect each account from unauthorized access by turning account passwords on.

1. Tap **Print on Envelopes** on the Home screen.
2. Tap **Account**.

3. Tap **Preferences**.



4. Tap **Manage Accounts**.

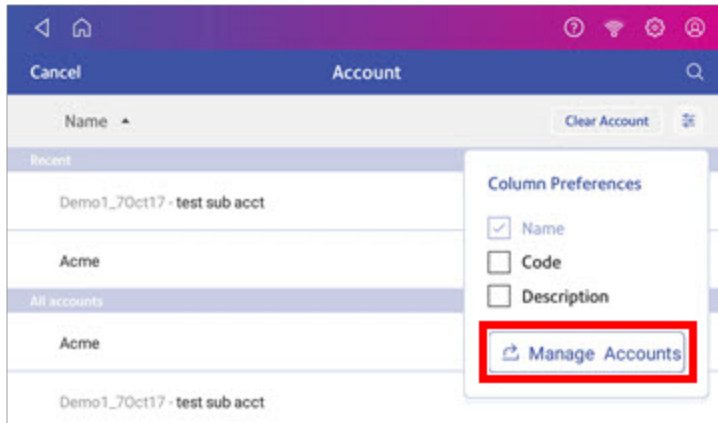

5. The Manage Accounts screen opens.

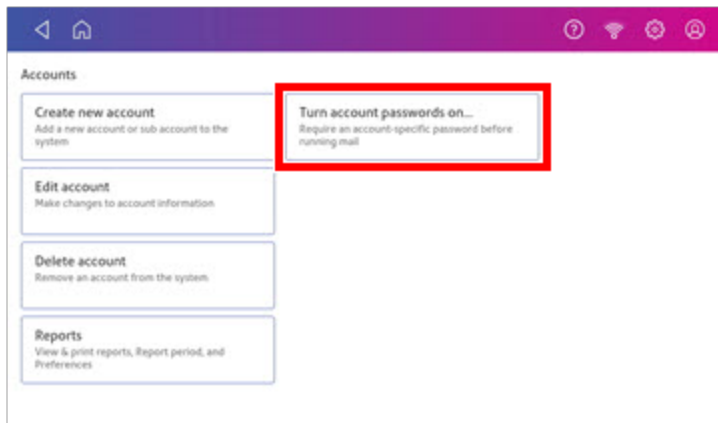

- Tap **Turn account passwords on** if account passwords are off and you wish to turn them on. Tap **OK**.
 - Tap **Turn account passwords off** if account passwords are on and you wish to turn them off. Tap **OK**.
6. Tap the back arrow on the top left side of the screen to return to the list of accounts.
7. Tap **Cancel** to return to the Mail screen.

Adding a Print on Envelopes account

You can add a Print on Envelopes account to track your costs for printing postage on envelopes. This is different from your PB account which is used to fund your postage or shipping label costs.

Accounting is a feature that is optional and needs enabling if you want to use it. Contact your Pitney Bowes Sales Representative for information about options and pricing.

1. Tap **SendPro Apps** on the Home screen.
2. Tap **Manage Accounts**.
3. Tap **Create new account**.
4. Tap **Create a new account** for a new account.
5. Enter the account name in the Enter account name field. Account names can be up to 75 characters long.
If the keyboard does not pop up, tap the line in the gray box.
6. Enter a unique code in the Code field to identify each account. Codes can be alphanumeric. Codes help you locate accounts more easily.
7. You can use the optional fields, such as:
 - **Description** - Enter a description of the account up to 150 characters.
 - **Password** - Tap **Password** to add a password for an account.
 - Passwords are case sensitive, can be alphanumeric, and must be four characters in length. If you do set a password, you need to enter it to print mail.
8. Ensure you set the status to active.
9. Tap anywhere on the screen outside of the fields when complete.
10. Tap **OK** to save. The name of the new account appears.
 - Tap **Create New Account** to create another account.
 - Tap **Add a Sub Account to this account** to add a sub account to the account you just created.
 - Tap **Done** if you do not need to create any more accounts.
11. Press the **back arrow** to return to the account list.

Editing an account

Edit an account when you want to change the account name, code, description, status or password.

Important: Once you charge postage to an account, you cannot change the account name or code.

1. Tap **SendPro Apps** on the Home screen.
2. Tap **Manage Accounts**.
3. Tap **Edit account**.
4. Tap the account you want to edit.
5. Select **OK**.
6. Make your changes, such as edit the account name, code, description, status or password.
7. When finished, tap anywhere on the screen outside of the fields.
8. Tap **OK** to return to the Accounts screen.
9. Tap the back arrow to return to the list of accounts.
10. Tap **Cancel** to return to the Print on Envelopes screen.

Making an account inactive

Setting the account status to inactive prevents anyone from charging postage against an account.

1. Tap **SendPro Apps** on the Home screen.
2. Tap **Manage Accounts**.
3. Tap **Edit account**.
4. Tap the account you want to make inactive.
5. Select **OK**.
6. Tap the **Inactive** button.
7. When finished, tap anywhere on the screen, but outside of the fields.
8. Tap **OK** to return to the Accounts screen.
9. Tap the **back arrow** to return to the list of accounts.
10. Tap **Cancel** to return to the Print on Envelopes app.

Deleting an account

If you apply postage to an account, you cannot delete the account. You can only make the account inactive.

Make sure you do not need an account's data before you delete an account. When you delete an account, sub account or sub sub account, you delete its data. You cannot recover that data.

1. Tap **SendPro Apps** on the Home screen.
2. Tap **Manage Accounts**.

3. Tap **Delete account**. The list of available accounts appears.
4. Tap the account you want to delete.
5. Tap **OK**.
6. Tap **Yes, delete account** to confirm.
7. Tap **OK**.
8. Tap the back arrow to return to the list of accounts.
9. Tap **Cancel** to return to the Print on Envelopes screen.

Creating presets for printing postage

Create presets to store a group of commonly-used settings. Presets can store settings such as a postage class, an account and a graphic. The maximum number of presets you can have is 21. This includes the default preset.

1. Tap **Print on Envelopes** on the Home screen.
2. Tap **Class**, select the class and any special services, messages or graphics.
3. Verify the settings in the Print on Envelopes app.
4. Tap the **star** in the Preset box.

Important: You must modify something in the Print on Envelopes app for the Preset star to appear.

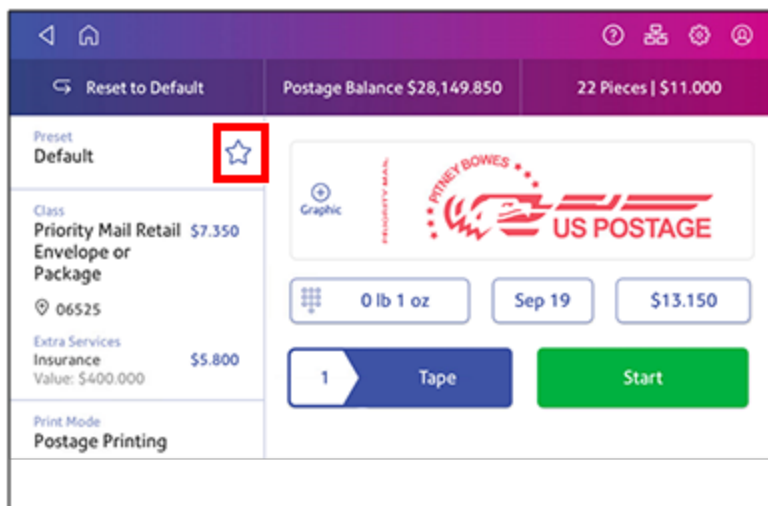

5. Tap **Save New Preset** to save it. If you wish to save it and replace the default setting, tap **Replace Default Preset**.

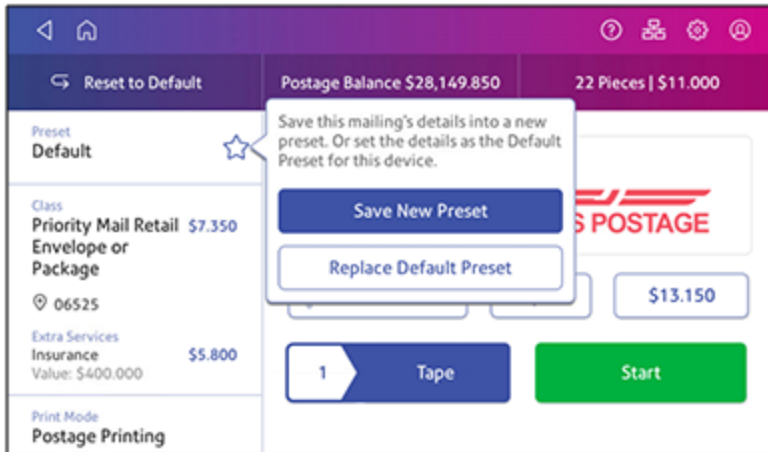

6. For a new preset, enter a name, then tap **Save**.

Viewing presets for printing postage

1. To view the presets, tap the **Preset** box on the Print on Envelopes screen.
2. Tap each preset to view its settings.

Selecting a preset for printing postage

Select a preset to quickly apply a group of settings.

1. Tap **Print on Envelopes** on the Home screen.
2. Tap **Preset**.
3. Tap the preset you want to use, then tap **Apply Preset**.

If you select a preset and do not use it within about one minute, the Print on Envelopes screen restores the default preset values. The same is true when you switch your device off or it enters sleep mode.

Modifying presets for printing postage

Modify a preset to rename a preset, replace the default preset or delete a preset.

1. Tap **Print on Envelopes** on the Home screen.
2. Tap **Preset**.
3. Tap the preset you wish to modify.
4. Tap **Options**.

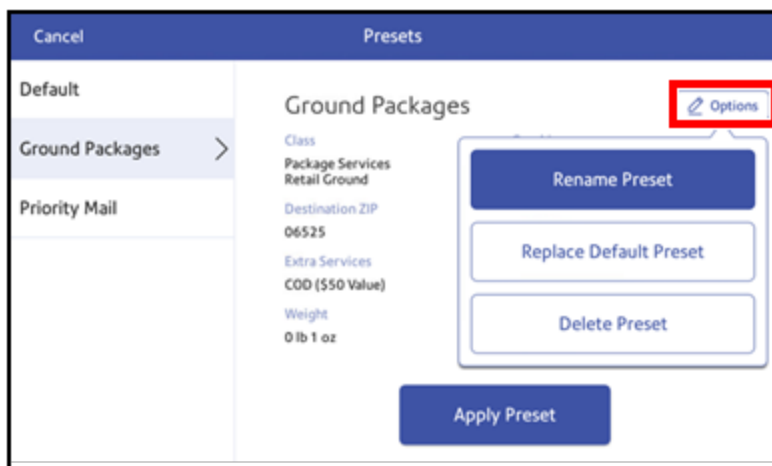

5. Tap the option you want.

Setting the default preset timer

The default preset timer will reset your device to your most commonly-used settings. By default, the preset timer resets your device after one minute of inactivity. You can change this time if necessary.

1. Tap **Settings**.



2. Scroll down to the Envelope Printer Settings section.
3. Tap **Postage Refills**.
4. Tap **Default Preset Timer**.

5. Use the slider to set the time between 1 and 9 minutes.

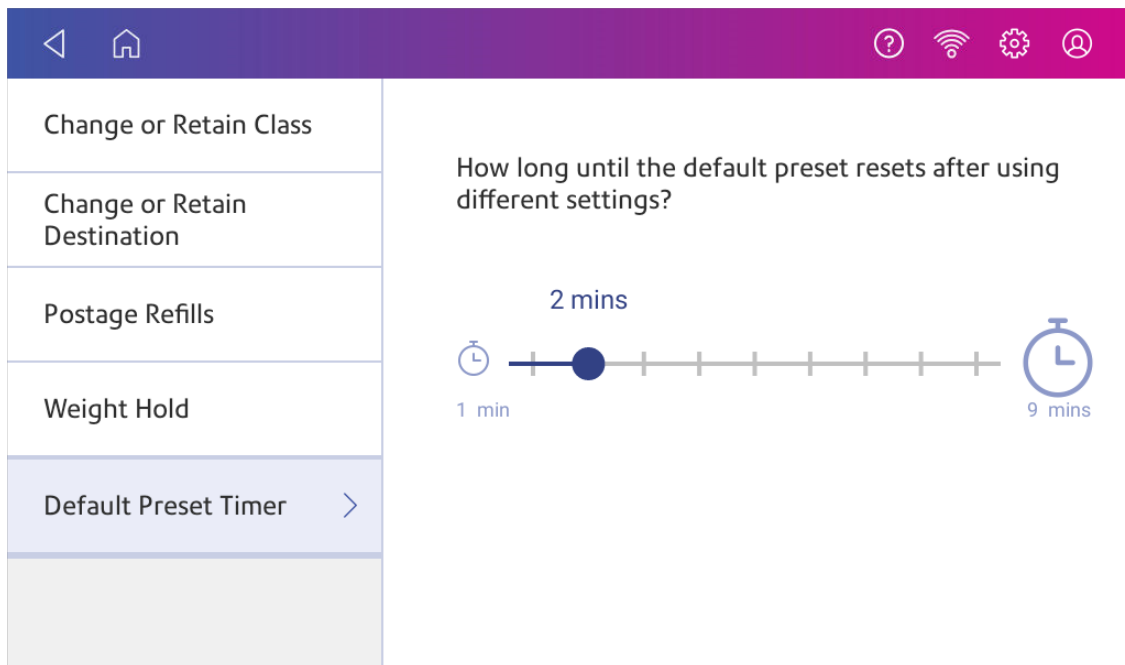

6. To save the value and exit the screen, tap the **back arrow** or **Home**.

8 - View and Print Reports

In this section

Viewing a receipt when refilling postage.....	164
Viewing the total spent on printing postage.....	164
Viewing the refill history for printing postage.....	164
Printing a funds report.....	164
Running account reports.....	165
Emailing an account report.....	166
Setting the report period for an account.....	167
Setting the account report preferences.....	168
Creating a shipping report.....	169
Creating a USPS shipping label refund report.....	169

Viewing a receipt when refilling postage

Use the Print Refill Receipt app to view receipts of previous postage refills.

- Tap **SendPro Apps** on the Home screen, then tap **Print Refill Receipt**.

Viewing the total spent on printing postage

View the total amount you have spent on postage and the total number of pieces printed.

1. Tap **Settings**.



2. Scroll down to the Envelope Printer Settings section.
3. Tap **Postage Refills**.
4. Tap **Advanced** to view the total amount of postage spent and the number of pieces printed.

Viewing the refill history for printing postage

View a report showing all your postage refill history.

1. Open the Refill History screen:
 - Tap **SendPro Apps** on the Home screen, then tap **Print Refill Receipt > Refill History**, or
 - Tap the **History & Reports** icon in the application drawer, then tap **Refill History**.
2. Tap on a postage refill to open a Refill Receipt.

Important: At this time, you can only view the report.

Printing a funds report

Print a funds report if you need a report showing the total number of mailpieces sent.

The funds report provides the following information about your device:

- **Used:** The total amount used over the lifetime of the device.
- **Available:** The amount currently available to print.
- **Total Pieces:** The total number of mailpieces run over the lifetime of the device.
- **Control Sum:** The control sum is the total of the amount used and available.
- **Batch Count:** The current Batch Count.
- **Batch Value:** The current Batch Total.
- **PBP Serial No:** The serial number of the device.
- The date and time the report was printed.

To print a funds report:

1. Tap **Print on Envelopes** on the Home screen.
2. Tap the piece count in the upper right.
3. Tap **Print Report**.
4. Tap **SendPro C Envelope Printer**.
5. Place the envelope on the feed deck. Depending on the SendPro C model you have, feed the envelope manually or tap **Start** to feed the envelope.
6. Tap the **back arrow** to return to the Print on Envelopes app.

Running account reports

Run account reports to show how you spent your postage for a specific account or for all accounts over various time periods.

1. Tap **SendPro Apps** on the Home screen.
2. Tap **Manage Accounts**.
3. Tap **Reports**.
4. If this is the first time you are running a report:
 - a. Tap **Report Period** and set the time range for your reports.
 - b. Tap **Preferences** and set how to you wish to identify the accounts.
5. Set the report period.
6. Tap **View & print reports**.
7. Tap to select a report.
8. Tap **Next**.

9. Choose what to do with the report:
 - To view the report on the screen, tap **View Report**.
 - Tap **Actions** to save the report under a new name, delete, print, or email the report. In order to print a report, you need an optional report printer.

Emailing an account report

Email an account report to keep a record of how much departments or clients have spent on their postage over specific time periods.

1. Tap **SendPro Apps** on the Home screen.
2. Tap **Manage Accounts**.
3. Tap **Reports**.
4. Tap **View & print reports**.
5. Tap the report to select it.
6. Tap **Next**.
7. Tap **Actions** or **View Reports** at the bottom of the screen.
8. Tap **Email Report**.

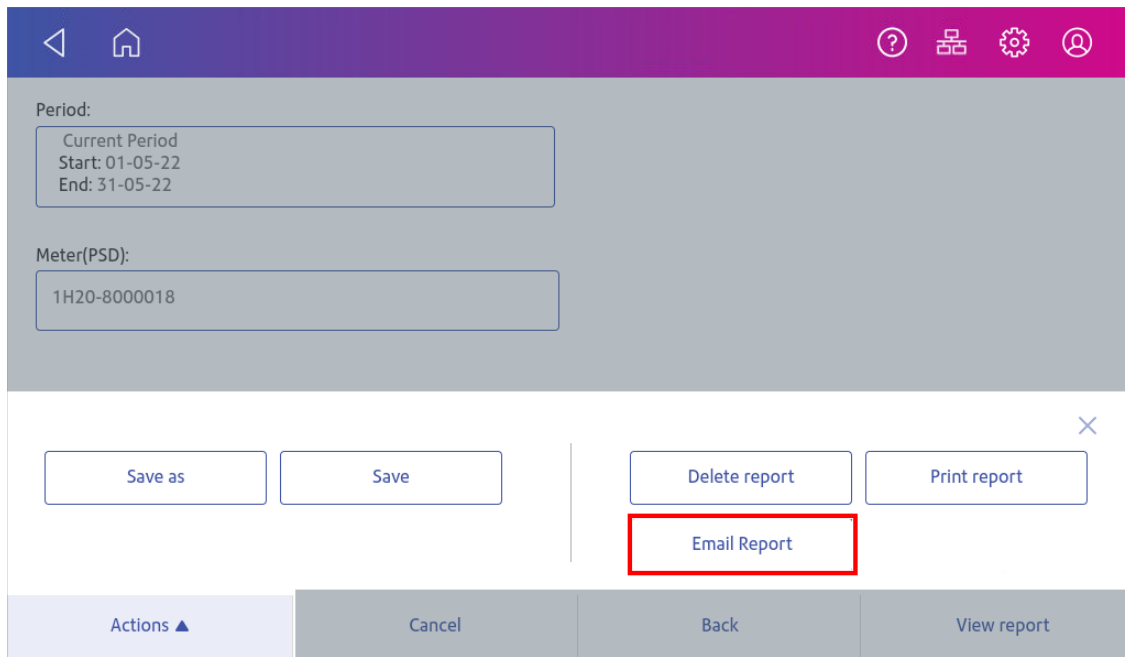

The screenshot shows a mobile application interface for viewing and printing reports. At the top, there is a purple header bar with navigation icons (back, home, help, menu, settings, profile). Below the header, the screen is divided into two main sections. The first section, titled 'Period:', contains a text box with the following text: 'Current Period', 'Start: 01-05-22', and 'End: 31-05-22'. The second section, titled 'Meter(PSD):', contains a text box with the value '1H20-8000018'. Below these sections, there is a white area with a close button (X) in the top right corner. This area contains four buttons: 'Save as', 'Save', 'Delete report', and 'Print report'. The 'Email Report' button is highlighted with a red border. At the bottom of the screen, there is a dark grey bar with four buttons: 'Actions ▲', 'Cancel', 'Back', and 'View report'.

9. Tap in the **Please enter the recipient mail address** box and enter the recipient's email address. The email address you enter will remain until you turn off then turn on the device.

* Please enter the recipient mail address:

* Attach report as file type:

.xlsx

.csv

.pdf

* Required fields

Cancel Send

10. Tap the file type you wish to send: **xlsx** (Excel), **csv** (comma-separated values), **pdf** (Portable Data Format).
11. Tap **Send**. The report appears from no-reply@pb.com.

Setting the report period for an account

Set the reporting period of an account report by setting its start and end dates.

1. Tap **SendPro Apps** on the Home screen.
2. Tap **Manage Accounts**.
3. Tap **Reports**.
4. Tap **Report period**.

5. Select the calendar image next to the **Start date of fiscal year** field.

Report period defaults

Start date of fiscal year:
01.01.2023

End date of fiscal year:
31.12.2023

Default reporting period:
Calendar month

Calendar month periods for 2023:

Month 1	01.01.2023 to 31.01.2023
Month 2	01.02.2023 to 28.02.2023
Month 3	01.03.2023 to 31.03.2023
Month 4	01.04.2023 to 30.04.2023
Month 5	01.05.2023 to 31.05.2023

< Previous year Next year >

OK

- a. Select a date on the calendar.
 - b. Select **SET**.
- The End date of the fiscal year is set based on the start date you enter. You cannot enter this date manually.
6. Select the **Default reporting period** field.
 - a. Select a report period type.
 - b. Select **OK**.
 7. (Optional) Tap **Previous year** and **Next year** to view the reporting periods for the previous and next year. Tap **up** and **down** to scroll through the list of reporting periods for the current year.
 8. Tap **OK** to return to the Reports screen.

Setting the account report preferences

Set the account report preferences to select the account level you wish to report on (Account, Sub account or Sub sub account).

You can also choose how you want to identify accounts: by Name or by Code.

1. Tap **SendPro Apps** on the Home screen.
2. Tap **Manage Accounts**.
3. Tap **Reports**.
4. Tap **Preferences**.
5. Tap to select how you want to identify accounts: by **Name** or by **Code**.
6. Select the account level you wish to report on: **Account**, **Sub account** or **Sub sub account**.
7. Tap **OK** to return to the Reports screen.

Creating a shipping report

You can view and print a report of the shipping labels you have created on your device using the Shipping History app. This app provides a summary of your past shipping labels with the Date, Recipient, Carrier, Tracking Number (USPS), Status, and Label Amount.

The maximum number of shipping labels you can view for any date range is 200.

1. Tap **SendPro Apps** on the Home screen, then tap **Shipping History**.
2. By default, all the shipping labels you have created appear. Tap **All Shipment** to filter by shipment status. Then, select a status. For example, if you want a report of all delivered packages, select **Delivered**.
3. To view the details of a specific shipping label, tap the shipment.
4. (Optional) To create an email report of all the shipments:
 - a. Tap **Create Report**.
 - b. Enter the email address. Tap the green check mark to confirm.
 - c. Tap **Email Report**.
 - d. You will receive an email with an attached .csv transactions history file.

Creating a USPS shipping label refund report

You can view and print all the USPS shipping label refunds you have requested on your device.

1. Tap **SendPro Apps** on the Home screen, then tap **Shipping History**.
2. Tap **All Shipments** and select **USPS Label Refund History**.

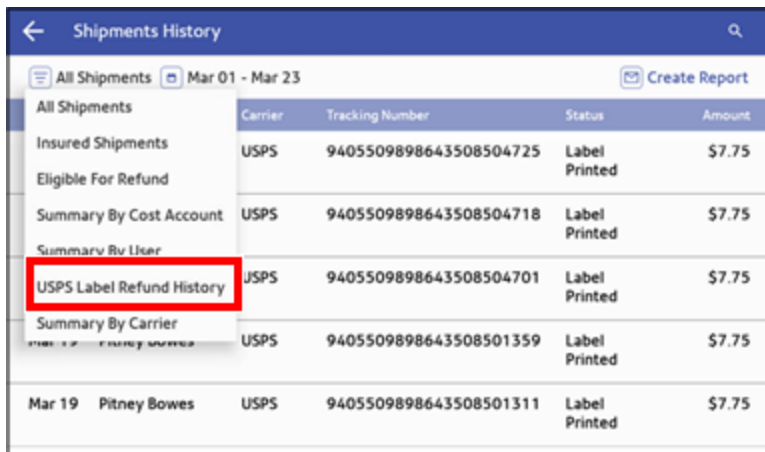

Shipments History					
All Shipments		Carrier	Tracking Number	Status	Amount
Insured Shipments	USPS	9405509898643508504725	Label Printed	\$7.75	
Eligible For Refund					
Summary By Cost Account	USPS	9405509898643508504718	Label Printed	\$7.75	
Summary By User					
USPS Label Refund History	USPS	9405509898643508504701	Label Printed	\$7.75	
Summary By Carrier	USPS	9405509898643508501359	Label Printed	\$7.75	
Summary By Carrier	USPS	9405509898643508501359	Label Printed	\$7.75	
Mar 19 Pitney Bowes	USPS	9405509898643508501311	Label Printed	\$7.75	

3. All the refunded USPS labels appear on the screen. To view the details of a specific shipping label refund, tap the shipment.
4. (Optional) To create an email report of all the USPS shipping label refunds:
 - a. Tap **Create Report**.
 - b. Enter the email address. Tap the green check mark to confirm.
 - c. Tap **Email Report**.
 - d. You will receive an email with an attached .csv transactions history file.

9 - Maintenance

In this section

Checking the postage print quality.....	172
Printing a test pattern.....	172
Checking the ink level.....	173
Replacing the ink cartridge.....	174
Changing the ink waste pad.....	176
Cleaning the printhead.....	178
Installing the printhead.....	183
Cleaning the moistener brush and wick assembly.....	188
Filling the moistener tank.....	192
Avoiding envelope sealing issues.....	193
Preventing envelope feeding problems.....	194
Moving the SendPro C Lite, SendPro C, SendPro+....	195

Checking the postage print quality

You can make a test print to check the quality of the postage printed on an envelope or tape strip.

1. Tap **Print on Envelopes** on the Home screen.
2. Tap **Print Mode**.
3. Scroll down and tap **Test Print**.
4. Tap **Apply**.
5. Feed an envelope or tape strip through the machine.
6. Check the print quality.



Printing a test pattern

Print a test pattern to see if the printhead is working properly or if you have enough ink in the cartridge.

1. Tap **Settings**.



2. Scroll down and tap **Mail Printer Maintenance**.
3. Tap **Print Test Pattern**.
4. Insert the envelope into the device when the message "Print a Test Pattern?" appears.

5. Examine the pattern printed on the envelope:
 - Tap **Done** if the lines are unbroken and match the "Good" test pattern shown on the display.
 - Tap **Clean Print Nozzle** if the test pattern has missing or incomplete lines
 - Once the cleaning operation completes, you must print another test pattern.
 - If this new pattern still has broken or missing lines, you may need to replace the ink cartridge or clean or replace the printhead.
 - If you see no improvement in print quality, do not repeat the cleaning, as cleaning the print nozzles consumes ink.

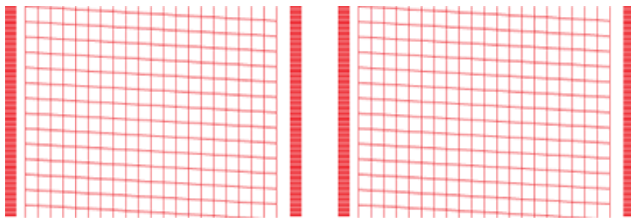

Good Test Pattern

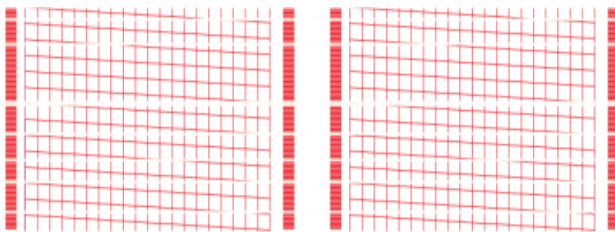

Bad Test Pattern

Checking the ink level

Check the ink level to ensure you have enough ink in your device.

1. Tap **Settings**.



2. Scroll down and tap **Envelope Printer Maintenance**.

3. View the level of remaining ink.

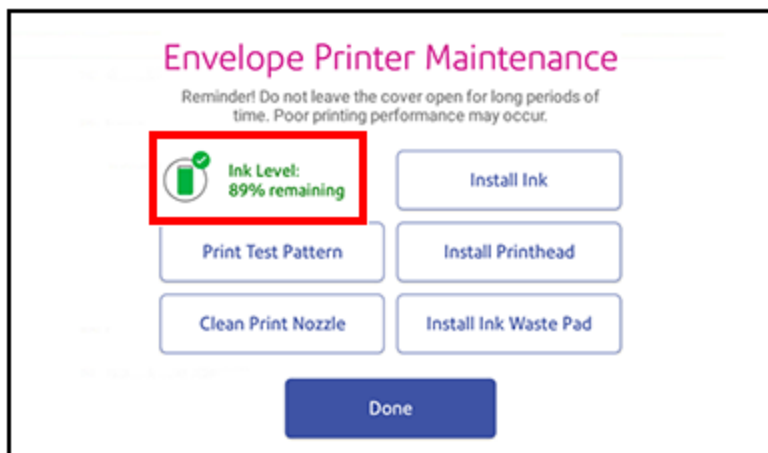

4. Tap **Done** to exit the screen.

Replacing the ink cartridge

Replace the ink cartridge when the low ink warning appears. This ensures your device is in optimal working condition.

1. Tap **Settings**.



2. Scroll down and tap **Mail Printer Maintenance**.
3. Tap **Install Ink**.
4. Lift the top cover. The ink cartridge moves to the front position.

5. Remove the ink cartridge, as shown on the label next to the cartridge holder.

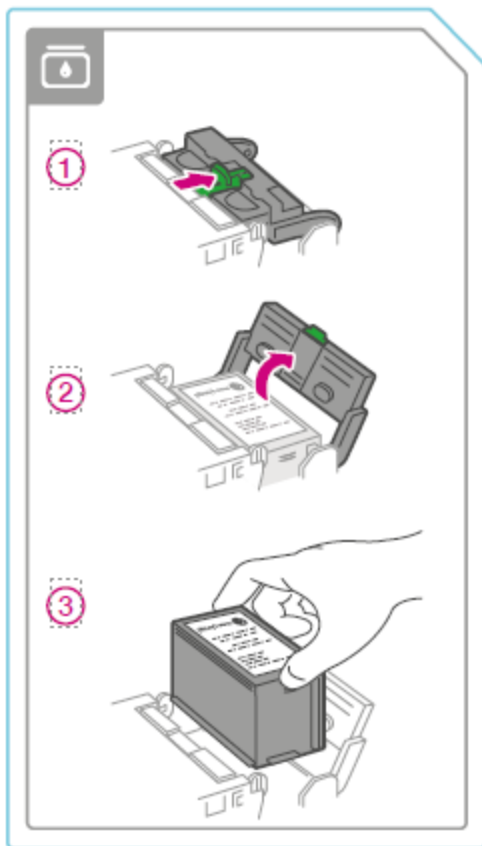

6. Insert the new ink cartridge, then close the ink cartridge guard.

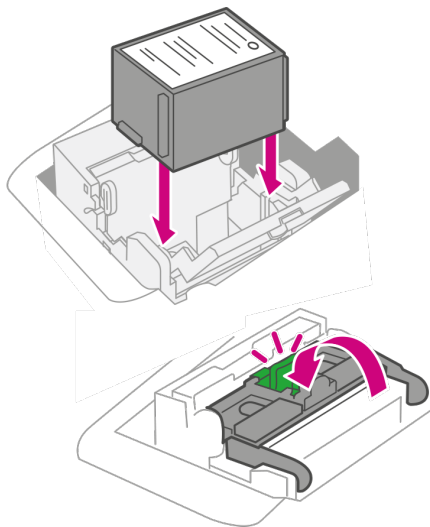

7. Close the top cover.

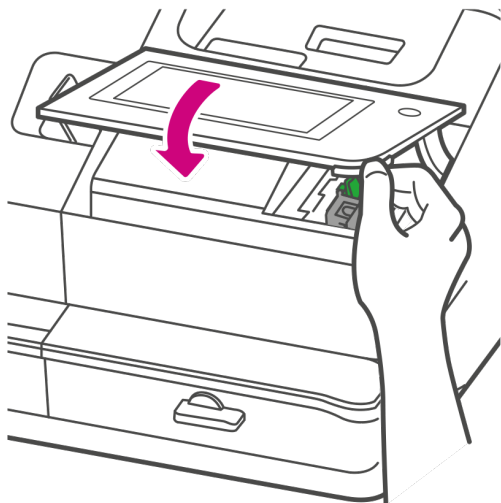

8. The cartridge repositions itself and the Mail Printer Maintenance screen appears.
9. Print a test pattern to ensure that your ink cartridge installs properly.

Changing the ink waste pad

Your device catches excess ink in a waste tank with a disposable pad. You will receive the following message at the top of the Print on Envelopes screen approximately 30 days before the ink waste tank becomes full:

"Ink waste pad is almost full. If you print often, replace it soon to avoid ink overflow."

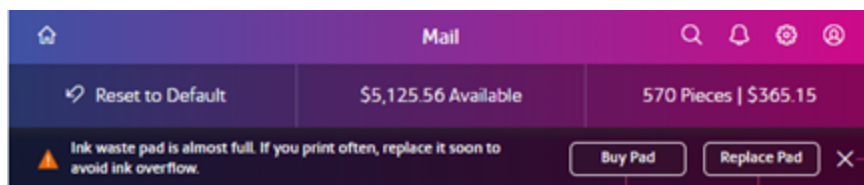

If the message is showing on the screen follow these steps:

To purchase replacement waste pad

Tap **Buy Pad**. The Supplies app appears where you can order a new pad right from the device.

To replace the pad

Before you replace the pad:

- Make sure you have a replacement waste pad available and you have the instruction sheet that comes with the pad. The sheet contains the reset code you will need in order to complete the replacement process.



1. Tap **Replace Pad**.
2. The instructions for replacing the existing pad display on the screen.
3. Follow the steps in each screen. To advance from one screen to the next, swipe to the left on the screen.
4. After you slide the waste tray with the new pad back in place, tap **Reset Ink Waste Counter** to continue.
5. Use the keypad to enter the reset code.
6. After you enter the code, the message "Your Ink Waste Pad is Ready to Use" displays. If you do not see this message, or if you still get a message that the waste tank is full, restart the device. If that fails to clear the message, contact Pitney Bowes support.

If the message no longer appears on the screen follow these steps:

If you need a replacement waste pad, use the Supplies app to purchase the pad.

To replace the pad:

1. Tap **Settings**.



2. Scroll down and tap **Envelope Printer Maintenance**.

3. Tap on **Install Ink Waste Pad**.

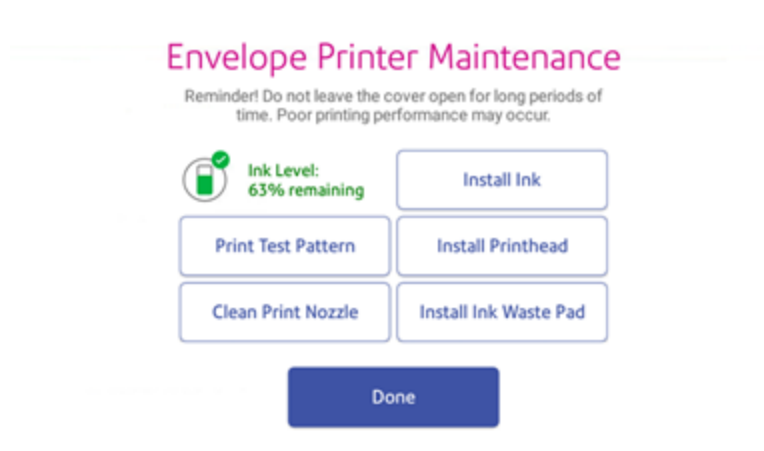

4. The instructions for replacing the existing pad display on the screen.
5. Follow the steps in each screen. To advance from one screen to the next, swipe to the left on the screen.
6. After you slide the waste tray with the new pad back in place, tap **Reset Ink Waste Counter** to continue.
7. Use the keypad to enter the reset code.
8. After you enter the code, the message "Your Ink Waste Pad is Ready to Use" displays. If you do not see this message, or if you still get a message that the waste tank is full, restart the device. If that fails to clear the message, contact Pitney Bowes support.

Cleaning the printhead

If you clean the print nozzle and you still get a bad test print pattern, try cleaning the printhead.

1. Tap **Settings**.



2. Scroll down and tap **Mail Printer Maintenance**.
3. Tap **Install Printhead**.
4. Lift the cover. The ink cartridge moves to the front position.

5. Flip the ink cartridge cover open.

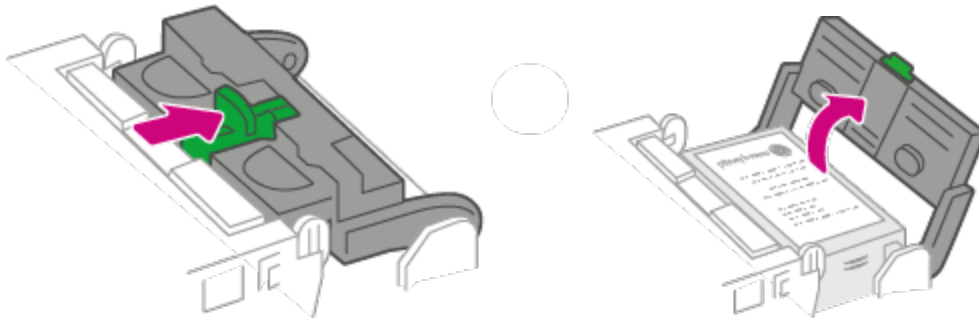

6. Remove the ink cartridge.

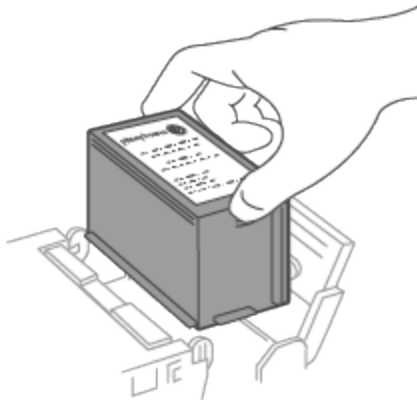

7. Squeeze the tabs on either side of the printhead.

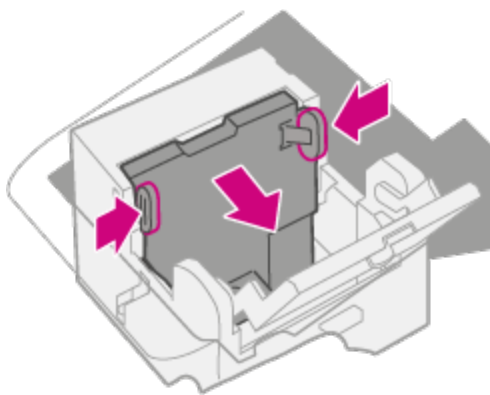

8. While squeezing, lift and tilt to the printhead to the right. The printhead should come up out of the device.

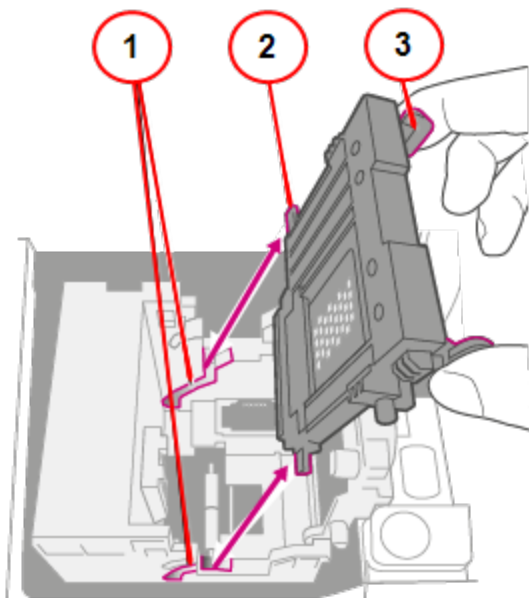

1. Grooves.
2. Peg.
3. Tab.

9. Clean off the printhead by wiping the surface of the printhead with a dry, lint-free cloth or a foam swab.

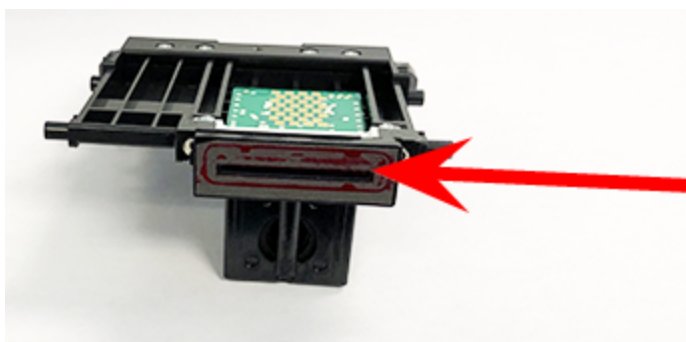

10. Squeeze the tabs and slide the printhead pegs into the lower set of grooves.

Warning: If you do not seat the printhead correctly it can damage the device.

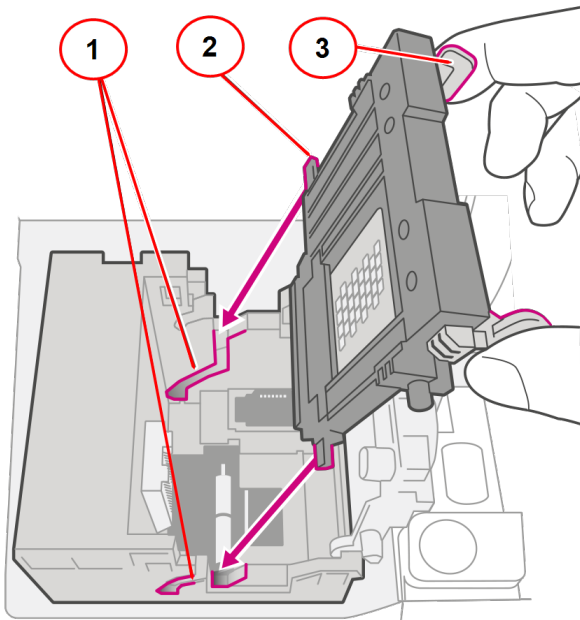

1. Grooves.
2. Peg.
3. Tab.

11. Keep squeezing the tabs and push the printhead flush against the wall. The tabs snap outward when placed correctly.

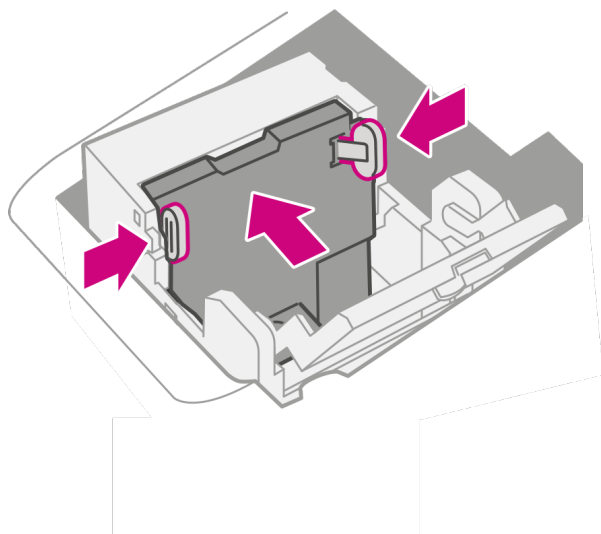

12. Install the ink cartridge and close the guard.

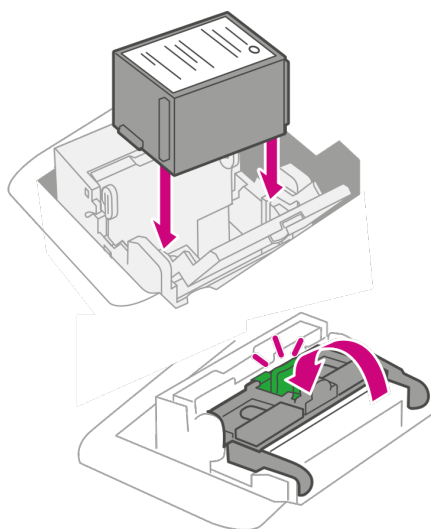

13. Close the cover. The ink cartridge moves back to the original position.

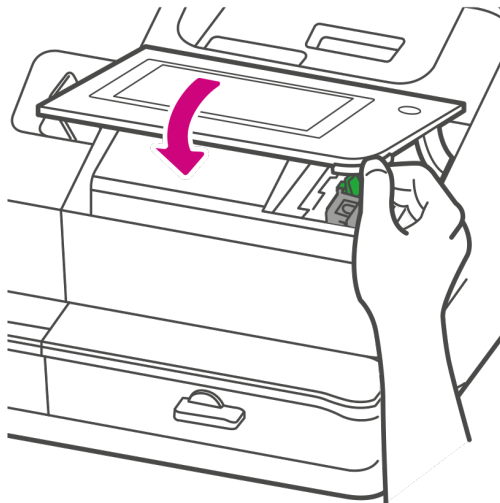

14. Tap **Done**.
15. Print a print test pattern to be sure that your printhead is functioning properly.
16. If the test pattern looks good, tap **Done**.

Installing the printhead

You may need to install a new printhead when the existing printhead is producing poor print quality.

1. Tap **Settings**.



2. Scroll down and tap **Envelope Printer Maintenance**.
3. Tap **Install Printhead**.
4. Lift the cover. The ink cartridge moves to the front position.

5. Flip the ink cartridge cover open.

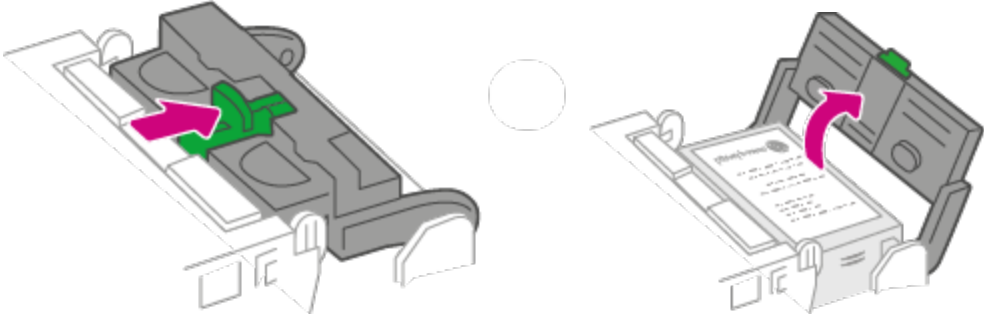

6. Remove the ink cartridge.

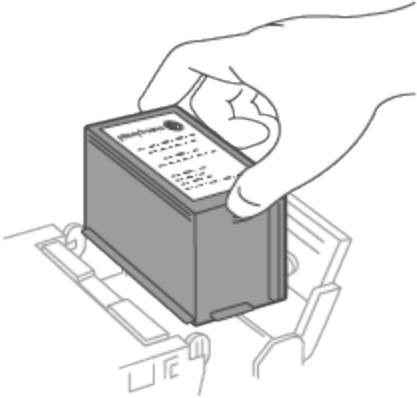

7. Squeeze the two gray tabs on either side of the printhead.

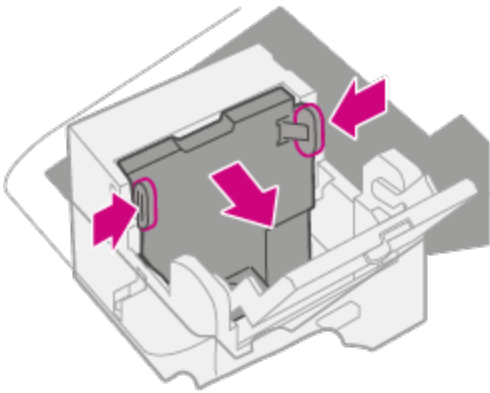

8. While squeezing, lift and tilt the printhead to the right. The printhead should come up out of the device.

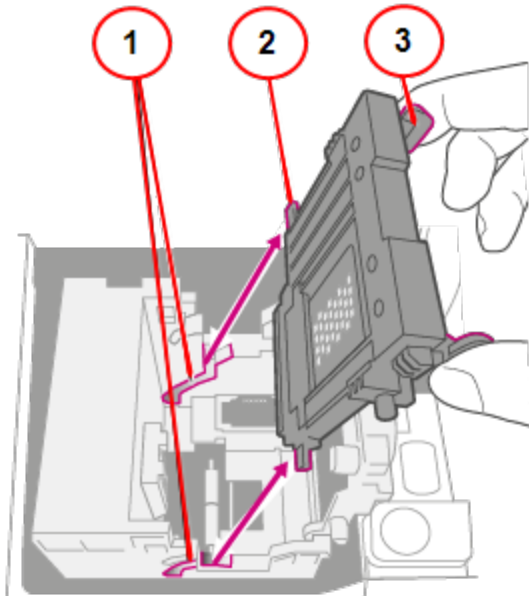

1. Grooves.
2. Peg.
3. Tab.

9. Unwrap the new printhead and remove the protective strip.

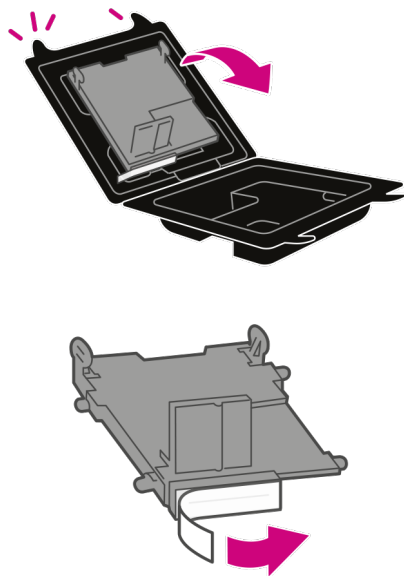

10. Squeeze the tabs and slide the printhead pegs into the lower set of grooves.

Warning: If you do not seat the printhead correctly it can damage the device.

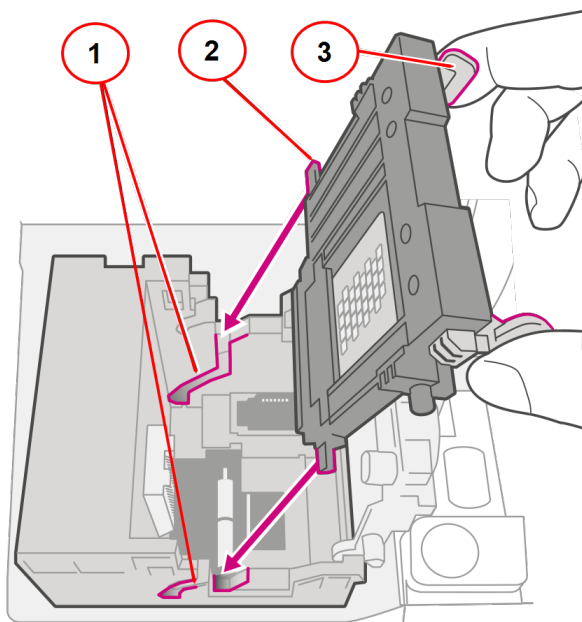

1. Grooves.
2. Peg.
3. Tab.

11. Keep squeezing the tabs and push the printhead flush against the wall. Tabs will snap outward when placed correctly.

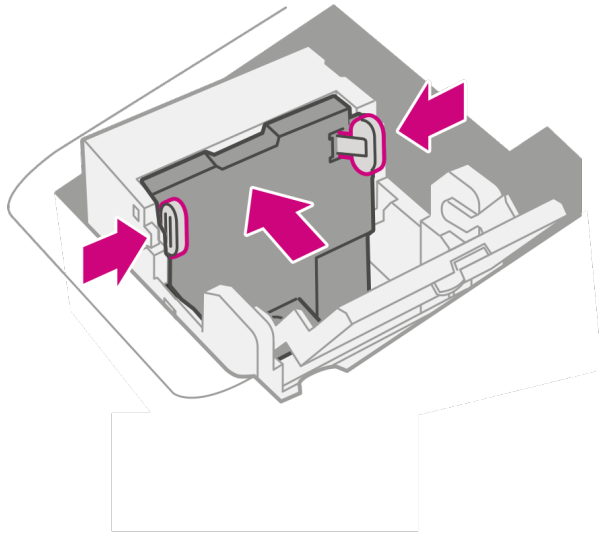

12. Install the ink cartridge and close the guard.

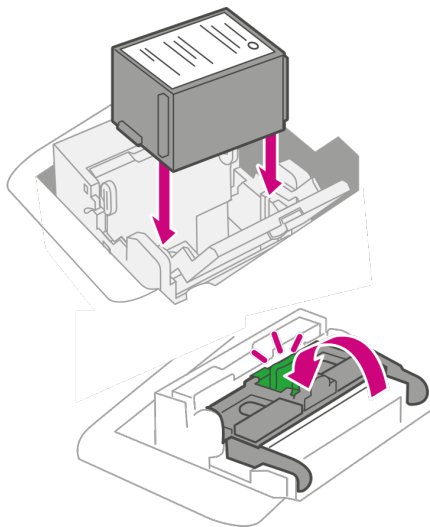

13. Close the cover. The ink cartridge moves back to the original position.

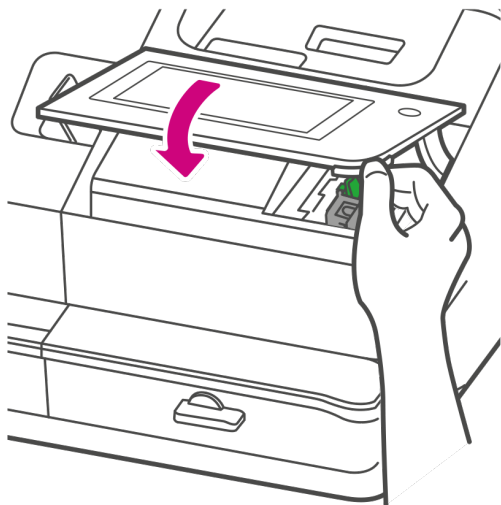

14. Tap **Done**.
15. Print a print test pattern to be sure that your printhead is working properly.

Cleaning the moistener brush and wick assembly

Clean the moistener brush and wick if the moistener tank is full and your envelopes are not sealing properly.

1. Unscrew the plastic thumbscrew under the moistener base.



2. Lift the moistener brush assembly off the top of the moistener base.



3. Turn the assembly over and slide the moistener brush out of the holder.

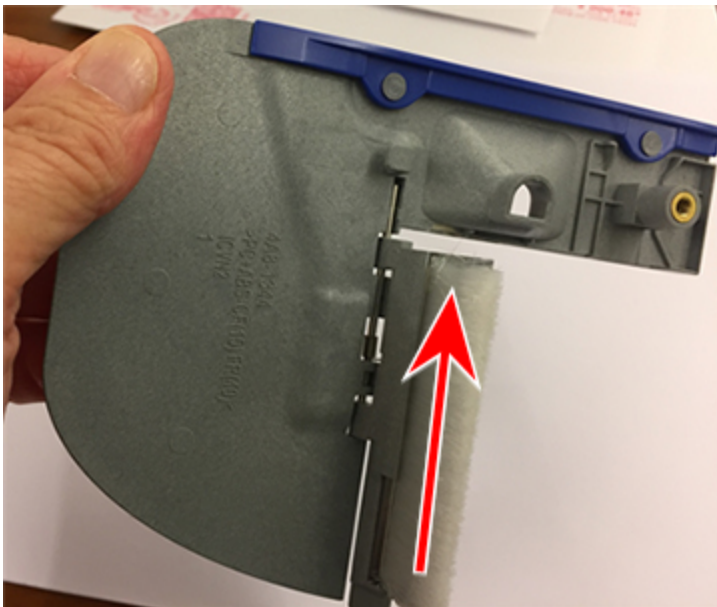

4. Locate the wick on the moistener base.

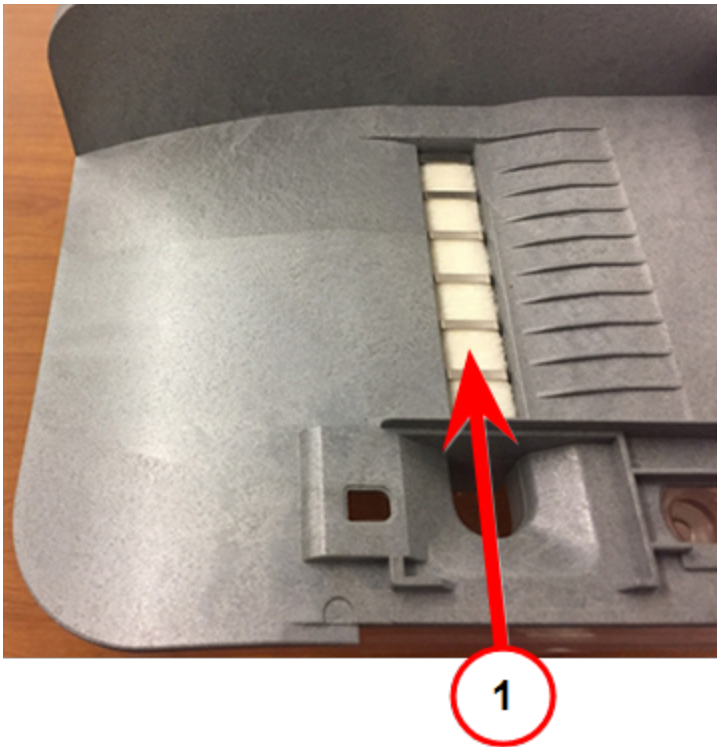

1. Wick.

5. Remove the metal grate and wick from the moistener base.





6. Clean the brush and wick with water and rinse thoroughly.
7. Place the wick back in the metal grate and replace the grate in the moistener base.
8. Slide the moistener brush back into the holder.
9. Replace the moistener brush assembly on top of the moistener base and secure with the plastic thumbscrew.
10. If your envelopes still are not sealing properly, you can order a Moistener Replacement Kit by visiting our [supplies website](#).

Filling the moistener tank

Your device will need refills of E-Z Seal® in order to seal envelopes. Follow these steps to fill the moistener tank.

1. Check the level of E-Z Seal® in your moistener tank (1).

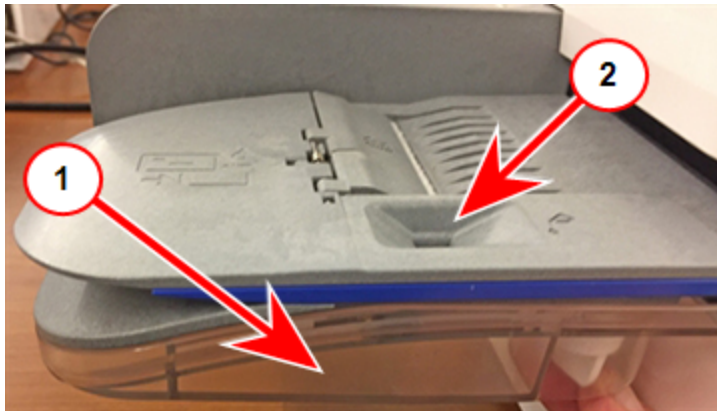

2. Add enough E-Z Seal® to bring the sealant level up to the bottom of the fill hole (2). Do not overfill the tank.
3. If the tank is empty, allow 30 minutes for the moistener brush and wick to get completely wet.

Avoiding envelope sealing issues

Prevent sealing issues by:

- Having enough sealant in the moistener tank.
 - Placing the envelope correctly on the feed deck.
 - Maintaining the wick or brush in the moistener.
1. Check the level of sealant in the moistener tank. Add more if required.

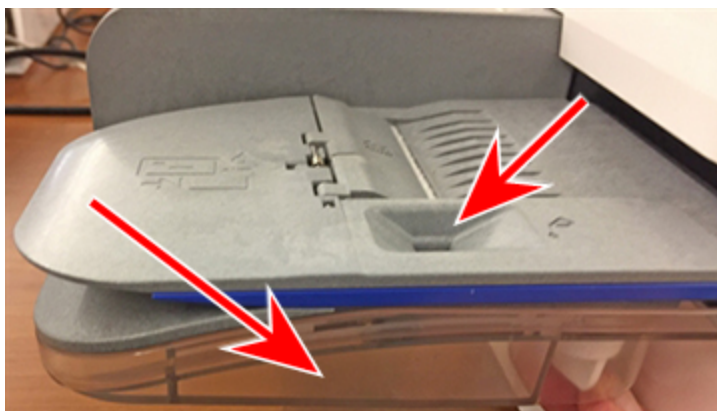

2. Slide the envelope flap under the edge of the feed deck when inserting an envelope. Otherwise, the moistener cannot wet the flap.



3. If the moistener tank is full, and your envelopes are still not sealing correctly, clean or replace your moistener brush and wick.

Preventing envelope feeding problems

Ensure you feed envelopes correctly to help prevent feeding problems.

Feeding mail

1. For your first envelope, hold the far edge of the envelope against the back wall of the feeder.
2. Slide the envelope into the feeder until you feel it touch the rollers. You hear the motor begin. Do not release the envelope until the feeder grabs it to pull it through the device.

3. You hear the motor continue to run for about 5 seconds once it prints postage on the envelope.
4. Continue to feed envelopes one at a time. Make sure you press the edge of each envelope against the back wall of the feeder and into the feeder until it touches the rollers.
 - Make sure the envelopes fully exit the feeder and do not pile up on the edge of the feeder.
 - If you are using a stacker, you may need to extend the stacker tray so that the envelopes exit the feeder completely.

Hold the envelope against the back wall to avoid skews

If you do not hold the envelope against the back wall, it can feed in crooked or skewed. A skewed envelope can either exit the device with no postage applied or cause a jam. The message Clear Paper Jam appears. This could deduct funds. Even a minor skew that may be difficult to see can cause a jam.

Preventive action

To prevent envelope feeding problems:

- Using a can of non-flammable compressed air, blow on the feed deck on the left side and work toward the transport deck on the right side. Make sure to remove all the dust and debris.

Moving the SendPro C Lite, SendPro C, SendPro+

Move your device safely, whether you are moving it across the room or to a new facility.

1. If you have a scale, remove it from the device.
2. Remove the moistener assembly. Once you have removed and cleaned the assembly, place it in a zip-top bag to prevent any remaining fluid from leaking.
3. Remove the ink cartridge. Once you get the ink cartridge out, place it in a zip-top bag.
4. Close the top cover.
5. Remove all USB cables and optional peripherals such as printers or scanners. Pack them with the device.
6. Unplug the power cord and pack it with the device.
7. Once in the new location, re-install all USB cables and peripherals.
8. Plug the power cord into the device and power outlet.

9. Re-install the ink cartridge.
10. Re-install the moistener assembly.

If you're moving to a new ZIP Code the device will need to be updated.

10 - Supplies

In this section

Ordering supplies.....	198
------------------------	-----

Ordering supplies

Visit our [supplies website](#) to order supplies for your device.

11 - Device Information

In this section

USPS requirements.....	200
Key in Postage.....	200
Sections of the meter impression.....	200
Finding the SendPro application software version.....	201
Postal Security Device.....	202
Parts of the SendPro C Lite, SendPro C, SendPro+.....	202
Connections on the back.....	203
Specifications.....	204
Material specifications.....	207

USPS requirements

Since your postage device (Postal Security Device) is licensed by the USPS, you must follow a few basic requirements.

- Mail must have the correct date and postage amount in the postage .
- Metered mail must bear the ZIP Code™ location of the post office where the device is registered.
- If you move to another ZIP Code™ location, you must update the ZIP Code. You can do this by chatting with Pitney Bowes support by visiting www.pitneybowes.com/us/support/sendproc.
- The USPS requires a postal inspection of your device every 120 days. Each time you refill your device through the network, the PB Postage device Payment System computer automatically performs a postal inspection.
- The postage tape you use must meet USPS specifications.

Key in Postage

The USPS requires your postage to be calculated using a scale. This ensures that your mail always has the correct postage, and that you are not overpaying, or having mail returned for insufficient postage. Key in Postage is not available on any of the SendPro C devices.

Sections of the meter impression

The meter impression contains elements that identify the mailer and the type of mail.

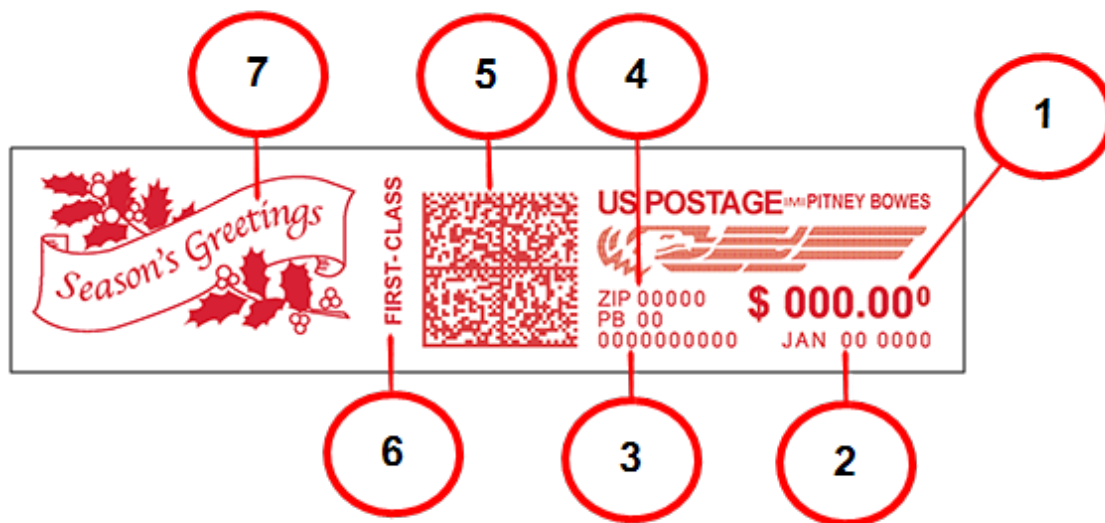

1. Postage amount
2. Date
3. Meter serial number
4. ZIP Code™ of the machine
5. Datamatrix barcode - contains tracking information
6. Optional postal inscription and class.
7. Optional graphic or Postal Endorsement (Postal Endorsements are official USPS instructions that print on the mailpiece).

Finding the SendPro application software version

SendPro is the software that runs many features on your device. If you need to check which version you have, follow these steps.

1. Tap **Settings**.



2. Scroll to Advanced Device Options.
3. Tap **About this Device**.

4. Scroll down to the Applications section and locate the **SendPro™** setting.

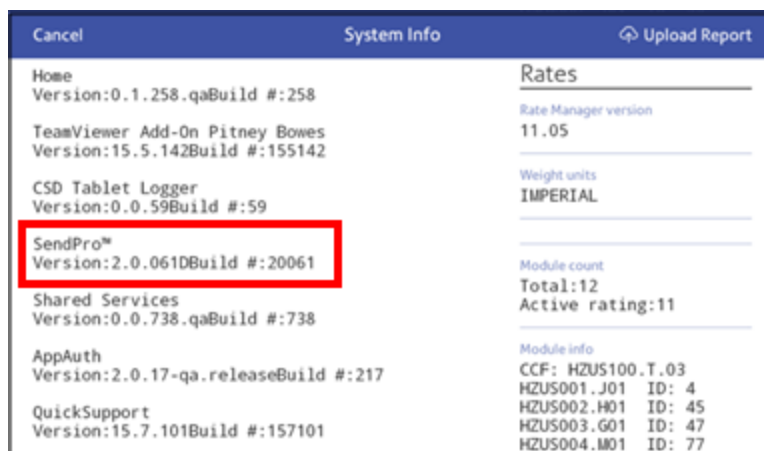

This is the most current software version.

5. Tap **Cancel** to exit the screen.

Postal Security Device

The postage meter on your mailing system is a Postal Security Device (PSD) that secures your postage funds. It includes the latest technology approved by USPS. This technology eliminates the need for USPS to perform physical inspections, thereby making your device easier and more convenient for you to use.

Parts of the SendPro C Lite, SendPro C, SendPro+

Familiarize yourself with the parts of your SendPro C Lite, SendPro C, SendPro+.



1. **Integrated scale** - Weigh envelopes and packages.
2. **Color touchscreen display** - Provides access to the apps available on your device.
3. **Ink access cover** - Allows access to the ink cartridge. Find the model and serial numbers inside.
4. **Envelope stacker** - Mail collects here after the printing process.
5. **Paper jam lever** - If a stall occurs on the transport deck, turn this to clear the envelope, post card or tape strip.
6. **Envelope moistener** - Moistens the flap of the envelope.
7. **Semi-automatic feeder** - Feeds and seals envelopes. Also feeds postcards and tape strips.
8. **Optional thermal label printer** - Prints shipping labels without using ink.

Connections on the back

Familiarize yourself with the ports on the back of your device.

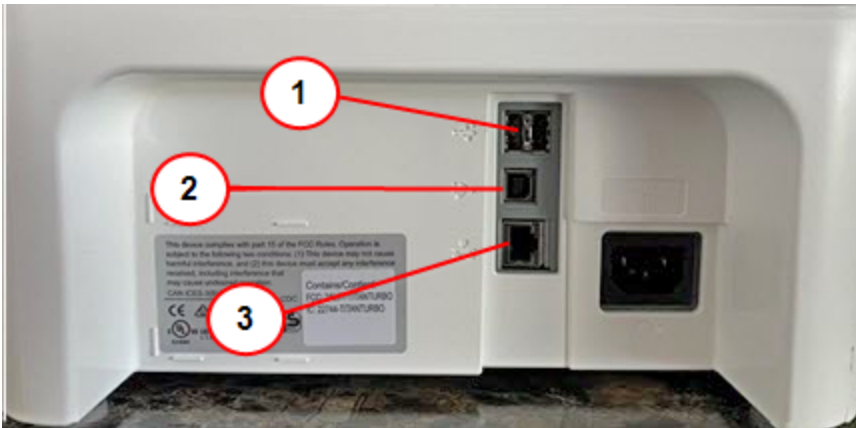

1. **USB port type A host** - Connect a Barcode scanner, external printer or external scale to these ports.
2. **USB port, type B host** - Service personnel use only.
3. **RJ45** - Use for a wired network connection.

Specifications

Review the specifications of your SendPro C Lite, SendPro C, SendPro+ including the throughput, ink cartridge yield and other component details.

Power requirements

100-240 VAC, 50/60 Hz, 1.0 A

Operating Temperature

55°F to 95°F

Sound Level

Less than or equal to 70 dBA re 20 micro Pascal in accordance with ISO 7779, ISO 3744, or ISO 3741.

Dimensions



1. Length 16.5 in
2. Width 15.5 in
3. Height 11.25 in

Weight

17.6 lbs

Throughput (Letters Per Minute)

- SendPro C® Lite - 50 letters per minute
- SendPro C®, SendPro®+ - up to 65 letters per minute

Actual throughput varies, depending on the material used, device condition, use of moistener, etc.

Ink Cartridge Life

- 17 ml cartridge - yields up to 1,500 impressions. (Actual ink yields vary with usage and environmental conditions).
- 35 ml cartridge - yields up to 3,000 impressions. (Actual ink yields vary with usage and environmental conditions).

Ports

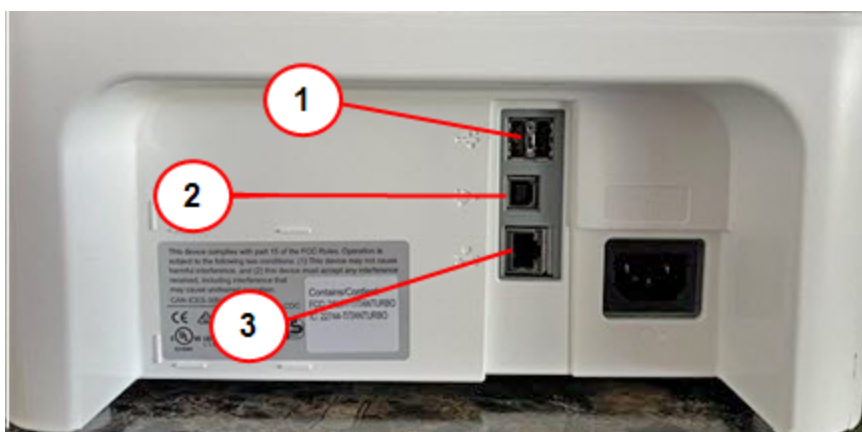

1. **USB port type A host** - Connect a Barcode scanner, external printer or external scale to these ports.
2. **USB port, type B host** - Service personnel use only.
3. **RJ45** - Use for a wired network connection.

Display

7-inch tablet (169 pixels/inch)

Print Resolution

300 H x 600 V dpi

Print Image Area

1 in x 7 in

Tapes and Strips

Self-adhesive, dual tape strip for use on mailpieces that are too large to run in the device. Ideal for adding postage to oversized envelopes, priority mail and packages.

Postal Inscriptions

Up to 60 inscriptions preloaded on the device.

Graphics

Up to 60 graphic ads on the device.

Connectivity Options

- Wired Ethernet connection.
- Wireless connectivity.
- SendPro Cellular connectivity device.

Material specifications

Review the material specifications including the minimum and maximum envelope sizes, envelope stack height, and tape size details.

Envelope dimensions

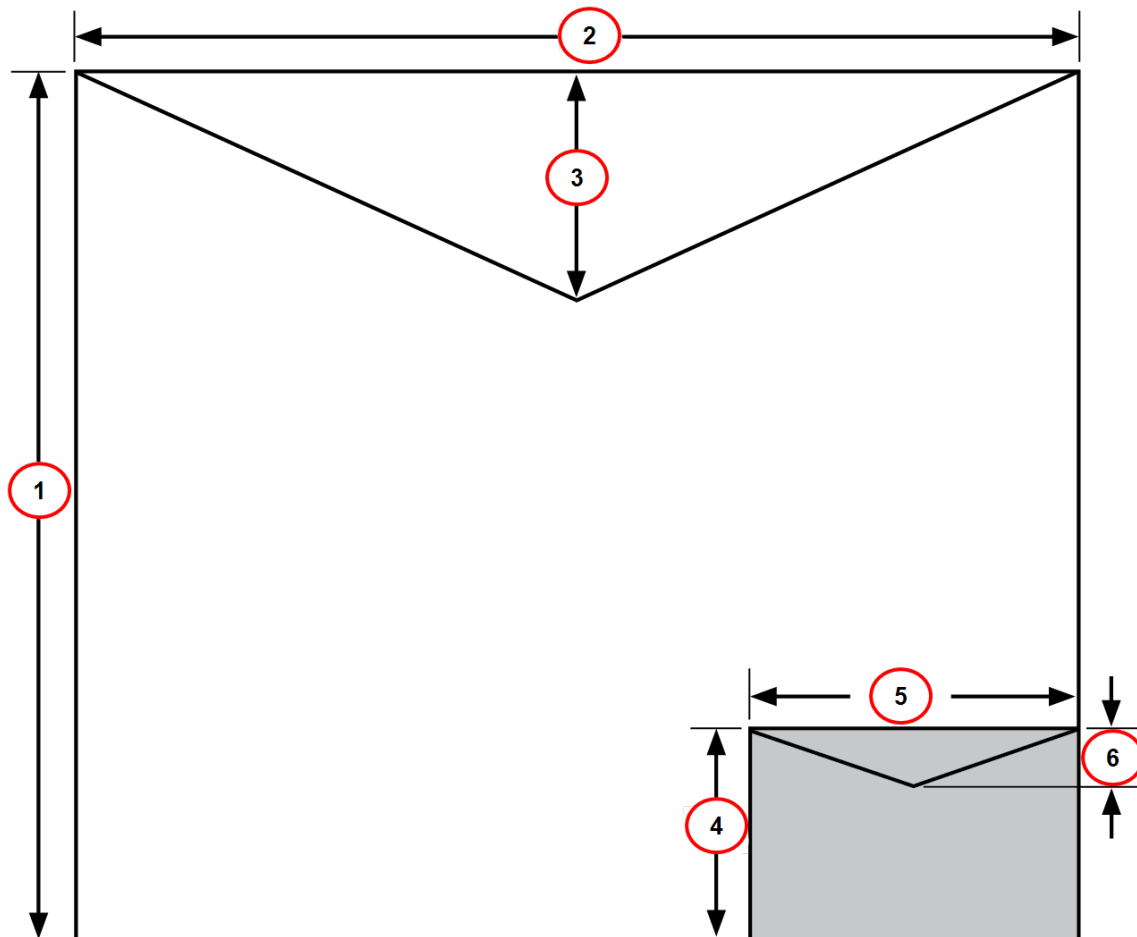

1. Maximum height: 13 in.
2. Maximum width: 15 in.
3. Envelope flap depth, maximum: 3 in
4. Minimum height: 3.5 in
5. Minimum width: 4.75 in
6. Envelope flap depth, minimum: 7/8 in

Envelope Thickness

- Minimum: 0.02 in
- Maximum: 3/8 in

Stack Height for Mail

- 3 in – This is the height of the inner edge of the side guide

Envelope Weight

- Minimum: 0.035 oz
- Maximum: 16 oz

Tape Size

- Minimum: 1.75 x 4 in
- Maximum: 1.76 x 8 in

For a proper seal, the envelope's minimum flap angle must meet the following criteria:

- For envelopes with a flap length from 1-2.36 in, the minimum flap angle is 18 degrees.
- For envelopes with a flap length greater than 2.36 in to the maximum flap length for the particular model, the minimum flap angle is 21 degrees.

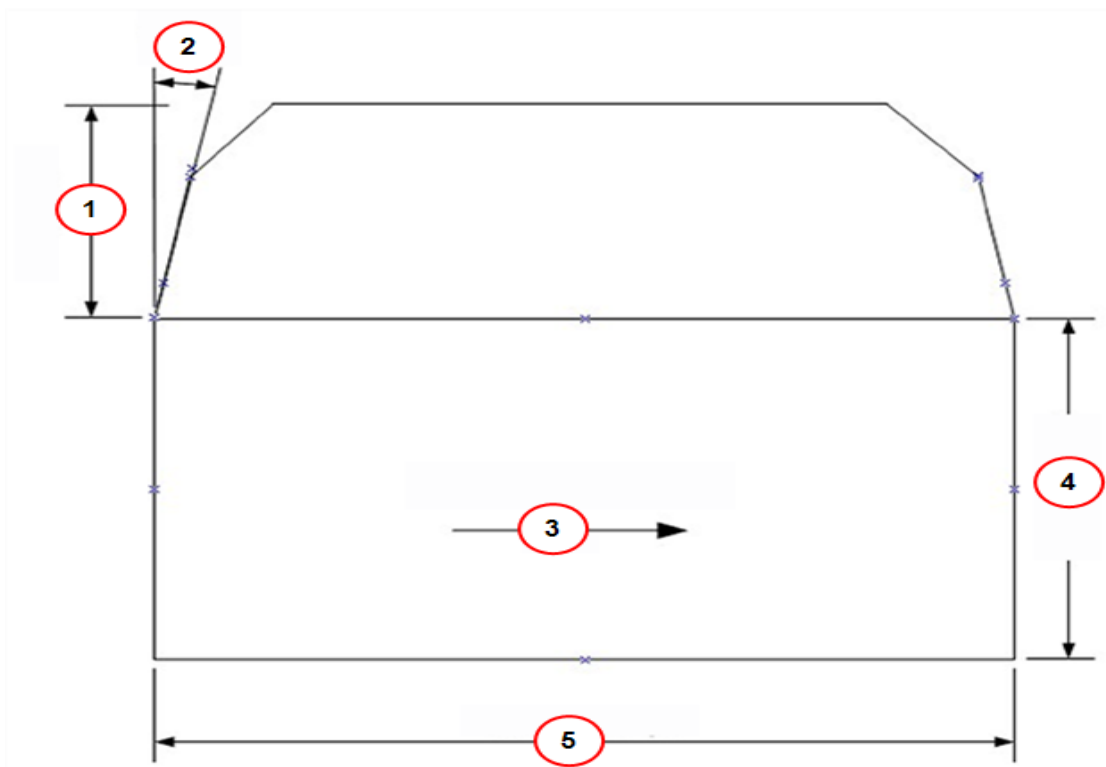

1. Flap length.
2. Minimum flap angle.
3. Mail processing direction.
4. Mailpiece length.
5. Mailpiece width.

12 - Contacting Pitney Bowes

In this section

Contacting Pitney Bowes.....	212
------------------------------	-----

Contacting Pitney Bowes

Before contacting Pitney Bowes Technical Support:

Locate your Product Code Number (PCN) and serial number

In order to find the correct information for your device, you need to know the model number.

To locate the **(1) Product Code Number (PCN)** and the **(2) 7-digit serial number**, check the label on the rear of the device or under the display cover as shown here. Note that the serial number appears blurred here for security reasons.

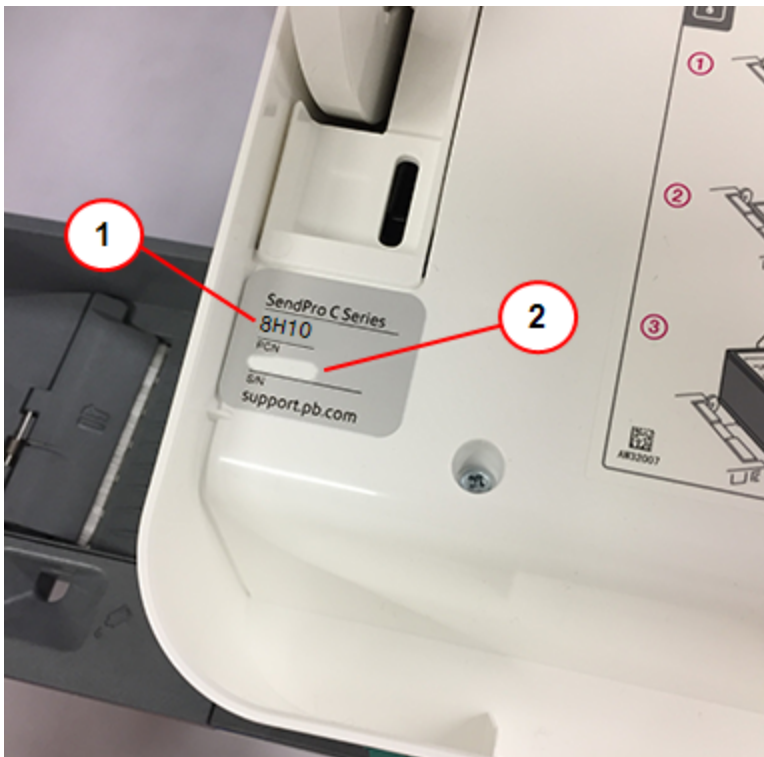

Be sure to have the following information available before contacting Pitney Bowes Technical Support:

Provide a description of the problem

- What is happening and when
- Are there any error messages?

Describe your attempts to fix the problem

- What steps have you already tried to fix the problem?
- If you tried, what happened?

Contact Technical and Account Support

Check the Pitney Bowes support site to make sure you have the latest information about your product. Visit us at: www.pitneybowes.com/support

For the Pitney Bowes Supplies

Web support: Visit our website at (copy the URL and paste it into a browser):

<https://www.pitneybowes.us/shop/ink-and-supplies/postage-meter-ink-supplies/sendpro-c-series/en-us/storeus>

Important: Customer service representatives are available Monday through Friday, 8:00 AM - 8:00 PM EST.

13 - Safety

In this section

Lithium Ion Battery.....	215
Agency Compliance Information.....	215
Important Safety Notes.....	215
Note for California Customers Only on all Models.....	217

SendPro C, SendPro+ (Model 2H00 and 8H00)

Power requirements: 100-240 VAC, 50/60 Hz, 1.0 A

SendPro C (All models)

- Operating Temperature: 55°F (13°C) to 95°F (35°C)
- Sound Level: Less than or equal to 70 dBA re 20 micro Pascal in accordance with ISO 7779, ISO 3744, or ISO 3741.

Lithium Ion Battery

This product contains a lithium ion battery. The battery must be recycled or disposed of properly. If you are leasing this product, you must return it to Pitney Bowes. Alternatively, contact your local waste disposal or recycle facility for instructions on how to dispose of it properly.

Agency Compliance Information

Agency Compliance Information can be found in the product's user guide. The user guide is available for download at: <http://www.pitneybowes.com/us/support>.

Important Safety Notes

Follow the normal safety precautions for all office equipment.

- Please read all instructions before you attempt to operate the system. Save these instructions for future use.
- Use only Pitney Bowes-approved supplies, in particular aerosol dusters. Improper storage and use of aerosol dusters or flammable aerosol dusters can cause an explosive-like condition that could result in personal injury and/or property damage. Never use aerosol dusters labeled flammable and always read instructions and safety precautions on the duster label.
- Use the power cord supplied with the machine and plug it into a properly grounded wall outlet that's located near the machine and easily accessible. Failure to properly ground the machine can result in severe personal injury and/or fire.

- The power cord wall plug is the primary means of disconnecting the machine from the AC supply. The unit is on whenever it is plugged into a live receptacle, even though the operator display may be blank.
- Place the mailing machine base close to an easily accessible wall outlet. DO NOT use a wall outlet controlled by a wall switch or one that is shared with other equipment.
- Do not use an adapter plug on the line cord or wall outlet.
- Do not remove the ground pin from the line cord.
- Make sure the area in front of the wall outlet into which the machine is plugged is free from obstruction.
- DO NOT route the power cord over sharp edges or trap it between pieces of furniture. Make sure there is no strain on the power cord.
- To reduce the risk of fire or electrical shock, DO NOT attempt to remove covers or disassemble the control panel or its base. The cabinet encloses hazardous parts. If you should drop or otherwise damage the unit, call Pitney Bowes.
- Use only Pitney Bowes approved ink, tape strips, and cleaners. To obtain Material Safety Data Sheets (MSDS) for OSHA requirements, please go to www.pb.com/msds. When prompted, enter the product name, manufacturer, the Pitney Bowes MSDS Number, or reorder number of the item you are interested in.
- Keep fingers, long hair, jewelry and loose clothing away from moving parts at all times.
- Avoid touching moving parts or materials while the machine is in use. Before clearing a stall (jam), be sure machine mechanisms come to a complete stop.
- To prevent overheating, do not cover the vent openings.
- When removing stalled material, avoid using too much force to protect against minor personal injury and damage to the equipment.
- Use the equipment only for its intended purpose.
- Always follow the specific occupational safety and health standards prescribed for your workplace.



Caution:

In case of an ink spill, leaking ink or excessive ink accumulation, immediately disconnect the power cord from the wall plug and contact Pitney Bowes. All inquiries can be done by visiting www.pitneybowes.com/us/support/sendproc. Customer Service Representatives are available Monday through Friday, 8:00 AM - 8:00 PM ET.

Note for California Customers Only on all Models

Batteries in this product contain perchlorate material. California requires perchlorate-containing products to be accompanied by the following notice: Perchlorate Material - special handling may apply. See: <http://www.dtsc.ca.gov/hazardouswaste/perchlorate/>

Servicing

Please refer to the warranty information if problems occur. For reference purposes, the Pitney Bowes U.S. Service Center contact address is: Pitney Bowes Inc., 3001 Summer Street, Stamford, CT, 06926. All inquiries can be done by visiting www.pitneybowes.com/us/support/sendproc. Customer Service Representatives are available Monday through Friday, 8:00 AM - 8:00 PM ET.

14 - Third party software

In this section

Third party software.....	219
---------------------------	-----

Third party software

Third party software may have been incorporated into this product by Pitney Bowes Inc. (“PBI”) under permission from PBI’s licensors. Any special terms and conditions that apply to such software are provided below:

This product contains the following software:

- Okhttp3 which is licensed under the Apache License, Version number 2.0. The license can be downloaded from: <http://www.apache.org/licenses/LICENSE-2.0.html>. The source code for this software is available from <http://square.github.io/okhttp/>.
- Retrofit which is licensed under the Apache License, Version number 2.0. The license can be downloaded from: <http://www.apache.org/licenses/LICENSE-2.0.html>. The source code for this software is available from <https://square.github.io/retrofit/>.
- Okio which is licensed under the Apache License, Version number 2.0. The license can be downloaded from: <https://github.com/square/okio/blob/master/LICENSE.txt>. The source code for this software is available from <https://github.com/square/okio>.
- Commons-codec which is licensed under the Apache License, Version number 2.0. The license can be downloaded from: <http://www.apache.org/licenses/LICENSE-2.0.html>. The source code for this software is available from https://commons.apache.org/proper/commons-codec/download_codec.cgi.
- Commons-io which is licensed under the Apache License, Version number 2.0. The license can be downloaded from: <http://www.apache.org/licenses/LICENSE-2.0.html>. The source code for this software is available from https://commons.apache.org/proper/commons-io/download_io.cgi.
- Org.greenrobot:eventbus which is licensed under the Apache License, Version number 2.0. The license can be downloaded from: <http://www.apache.org/licenses/LICENSE-2.0.html>. The source code for this software is available from <http://greenrobot.org>.
- Org.greenrobot:greendao which is licensed under the Apache License, Version number 2.0. The license can be downloaded from: <http://www.apache.org/licenses/LICENSE-2.0.html>. The source code for this software is available from <http://greenrobot.org/greendao>.
- FasterXml:jackson.core:jackson-core which is licensed under the Apache License, Version number 2.0. The license can be downloaded from: <http://wiki.fasterxml.com/JacksonLicensing>. The source code for this software is available from <http://wiki.fasterxml.com>.
- Aws-android-sdk-core which is licensed under the Apache License, Version number 2.0. The license can be downloaded from: <https://github.com/aws/aws-sdk-android/blob/master/LICENSE.APACHE.txt>. The source code for this software is available from <https://github.com/aws/aws-sdk-android>.

- Aws-android-sdk-iot which is licensed under the Apache License, Version number 2.0. The license can be downloaded from: <https://github.com/aws/aws-sdk-android/blob/master/LICENSE.APACHE.txt>. The source code for this software is available from <https://github.com/aws/aws-sdk-android>.
- Aws-android-sdk-s3 which is licensed under the Apache License, Version number 2.0. The license can be downloaded from: <https://github.com/aws/aws-sdk-android/blob/master/LICENSE.APACHE.txt>. The source code for this software is available from <https://github.com/aws/aws-sdk-android>.
- Nv-websocket-client which is licensed under the Apache License, Version number 2.0. The license can be downloaded from: <http://www.apache.org/licenses/LICENSE-2.0.html>. The source code for this software is available from <https://github.com/TakahikoKawasaki/nv-websocket-client>.
- bumptech.glide which is licensed under the Apache License, Version number 2.0. The license can be downloaded from: <http://www.apache.org/licenses/LICENSE-2.0.html>. The source code for this software is available from <https://github.com/bumptech/glide>.
- Jakewharton:butterknife which is licensed under the Apache License, Version number 2.0. The license can be downloaded from: <http://www.apache.org/licenses/LICENSE-2.0.html>. The source code for this software is available from <https://github.com/JakeWharton/butterknife>.
- Caverock:androidsvg which is licensed under the Apache License, Version number 2.0. The license can be downloaded from: <http://www.apache.org/licenses/LICENSE-2.0.html>. The source code for this software is available from <https://mvnrepository.com/artifact/com.caverock/androidsvg/1.2.1>.
- Glassfish:javax.annotation which is dual licensed under the CDDL, Version 1.0, and the GNU General Public License, Version 2, June 1991, with the Classpath Exception. The licenses can be downloaded from: <https://javaee.github.io/glassfish/LICENSE>. The source code for this software is available from <https://javaee.github.io/glassfish>.
- CalligraphyXamarin which is licensed under the Apache License, Version number 2.0. The license can be downloaded from: <http://www.apache.org/licenses/LICENSE-2.0.html>. The source code for this software is available from <https://github.com/mikescandy/Calligraphy-xamarin>.
- Newtonsoft JSON.NET which is licensed under the MIT License. The license can be downloaded from: <https://github.com/JamesNK/Newtonsoft.Json>. The source code for this software is available from <https://github.com/JamesNK/Newtonsoft.Json>.
- MaterialChips which is licensed under the Apache License, Version number 2.0. The license can be downloaded from: <http://www.apache.org/licenses/LICENSE-2.0.html>. The source code for this software is available from <https://github.com/DoodleScheduling/android-material-chips>.

- Android Open Source Project (“AOSP”), which is licensed under the Apache License, Version number 2.0. The license can be downloaded from: <http://www.apache.org/licenses/LICENSE-2.0.html>. AOSP also contains the Linux kernel which is licensed under GNU General Public License, Version 2, June 1991 (“GPL”). The license can be downloaded from: <http://www.gnu.org/licenses/gpl-2.0.html> Copyright © 1989, 1991 Free Software Foundation. For up to three years from PBI’s distribution of this product, you may obtain a complete machine-readable copy of the source code for the Linux kernel under the terms of the GPL, without charge except for the cost of the media, shipping, and handling, upon written request to PBI. Such requests should be sent by e-mail to iptl@pb.com.
- This product contains Paho.mqtt.java, which is licensed under the Eclipse Public License - v 2.0 and the Eclipse Distribution License - v 1.0. The licenses can be downloaded from <https://www.eclipse.org/legal/epl-2.0/> and <https://www.eclipse.org/org/documents/edl-v10.php>, respectively. The modified source code can be downloaded from: <https://github.com/PitneyBowes>.



3001 Summer Street
Stamford, Connecticut 06926
www.pitneybowes.com

For Service or Supplies

SV63317 Rev.P
©2024 Pitney Bowes Inc.
All Rights Reserved